



# INSTRUCTION MANUAL (ATEX / IECEx)

## BExBG15D and BExBG10D

### Flameproof Xenon Beacons

#### For use in Flammable Gas and Dust Atmospheres

### 1) Introduction

The BExBG15D and BExBG10D are flameproof beacons which are certified to meet the requirements of the ATEX directive 94/9/EC and the IECEx scheme. The beacons produce synchronised visual warning signals and can be used in hazardous areas where potentially flammable gas and dust atmospheres may be present. The BExBG15D has a flash energy of 15 joules and the BExBG10D has a flash energy of 10 joules. Both beacons can be used in Zone 1 and Zone 2 areas with gases in groups IIA, IIB and IIC and Temperature Classifications of T1, T2, T3 and T4. The beacons can also be used in the temperature classification T5, if the upper ambient temperature is restricted to +40°C. The units can be used in Zone 21 and Zone 22 areas for combustible dusts and have an IP rating of IP 67 and a surface temperature rating of T125°C or T110°C if the upper ambient temperature is restricted to +55°C or T95°C if the upper ambient temperature is restricted to +40°C.

### 2) Marking

All units have a rating label, which carries the following important information:-

Unit Type No. BExBG15D or BExBG10D

Input Voltage: DC Units 24V or 48V or 12V (10J only)  
AC Units 230V or 115V

Codes: Ex d IIC T4 for Ta -50°C to +70°C  
Ex d IIC T5 for Ta -50°C to +40°C  
Ex tD A21 IP67 T125°C based on max. Ta of +70°C

Certificate No's KEMA 00ATEX2006  
IECEx KEM 10.0002

Epsilon x:  II 2G/D  
Equipment Group and Category:

CE Marking  0518  
Notified Body No.

**“Warnings”** DO NOT OPEN WHEN AN EXPLOSIVE GAS OR DUST ATMOSPHERE IS PRESENT

COVER BOLTS CLASS A4-80

USE HEAT RESISTING CABLES AND CABLE GLANDS (Rated 110°C) AT AMB. TEMPERATURES OVER 40°C



Year of Construction/ Serial No. i.e. 10 / 1DB22000001

### 3) Type Approval Standards

The beacons have EC Type Examination and IECEx certificates issued by KEMA and have been approved to the following standards:-

EN60079-0:2006	IEC60079-0:2004 (Ed4)	General Requirements
EN60079-1:2007	IEC60079-1:2007 (Ed6)	Flameproof Enclosure 'd'
EN61241-0:2006	IEC61241-0:2004 (Ed1)	Dust General Requirements
EN61241-1:2004	IEC60079-1:2004 (Ed1)	Dust Enclosures tD

### 4) Installation Requirements

The beacons must be installed in accordance with the latest issues of the relevant parts of the EN60079 standards or the equivalent IEC standards – Selection, Installation and maintenance of electrical apparatus for use in potentially explosive atmospheres (other than mining applications or explosive processing and manufacture):-

EN60079-14:2008 Electrical Installations in Hazardous Areas (other than mines)

EN60079-10:2003 Classification of Hazardous Areas  
IEC60079-10:2008 (Ed1)

The installation of the units must also be in accordance with any local codes that may apply and should only be carried out by a competent electrical engineer who has the necessary training.

### 5) Zones, Gas Group, Category, IP Rating and Temperature Classification

The BExBG15D and BExBG10D beacons have been certified Ex d IIC T4 for Ta -50°C to +70°C and Ex d IIC T5 for Ta -50°C to +40°C for gas and IP67 T125°C based on max. Ta of +70°C. This means that the units can be installed in locations with the following conditions:-

#### Area Classification Gas:

Zone 1	Explosive gas air mixture likely to occur in normal operation.
Zone 2	Explosive gas air mixture not likely to occur, and if it does, it will only exist for a short time.

#### Gas Groupings:

Group IIA	Propane
Group IIB	Ethylene
Group IIC	Hydrogen and Acetylene

#### Temperature Classification:

T1	400° C
T2	300° C
T3	200° C
T4	135° C

T5	100° C	Amb. +40° C
----	--------	-------------

## Area Classification Dust:

Zone 21	Explosive dust air mixture likely to occur in normal operation.
Zone 22	Explosive dust air mixture not likely to occur, and if it does, it will only exist for a short time.

**IP Rating:** IP67 T125°C Ta ≤ +70°C  
T110°C Ta ≤ +55°C  
T95°C Ta ≤ +40°C

**Equipment Category:** 2G/D

**Ambient Temperature Range:** -50°C to +70°C  
(T5 = +40°C)

## 6) Beacon Location and Mounting

The location of the beacons should be made with due regard to the area over which the warning signal must be visible. They should only be fixed to services that can carry the weight of the unit.

**SAFETY WARNING:** The BExBG15D and BExBG10D 15 and 10 joule beacons must be mounted with their flashdome in a position between upright and 90° as shown.

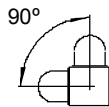

The beacons should be securely bolted to a suitable surface using the 7mm diameter boltholes in the stainless steel U shaped mounting bracket (see figure 1). The angle can then be adjusted as required but the mounting restrictions must be observed (see above). This can be achieved by loosening the two large bracket screws in the side of the unit, which allow adjustment in steps of 18°. On completion of the installation the two large bracket adjustment screws on the side of the unit must be fully tightened to ensure that the unit cannot move in service.

**SAFETY WARNING:** The flashdome guard must not be removed from the unit at any time.

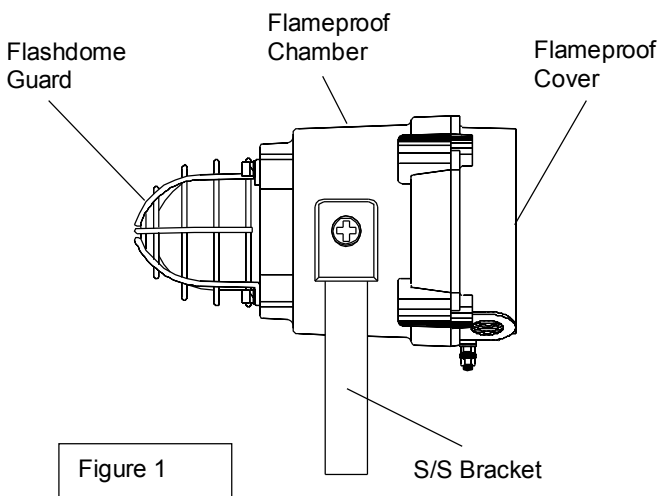

Figure 1

## 7) Access to the Flameproof Enclosure

In order to connect the electrical supply cables to the beacon it is necessary to remove the flameproof cover to gain access to the flameproof chamber. To achieve this remove the four M6 hexagon socket head screws (see figure 2) and withdraw the flameproof cover taking extreme care not to damage the flameproof joints in the process.

Note the four **M6 screws are Class A4-80 stainless steel and only screws of this category can be used on these beacons.** It is therefore important that these screws and their spring washers are kept in a safe place during installation.

On completion of the cable wiring installation the flameproof joints should be inspected to ensure that they are clean and that they have not been damaged during installation. Also check that the earth bonding wire between the two casting sections is secure and the 'O' ring seal is in place. When replacing the flameproof cover casting ensure that it is square with the flameproof chamber casting before inserting. Carefully push the cover in place allowing time for the air to be expelled. Only after the cover is fully in place should the four M6 Stainless Steel A4-80 cover bolts and their spring washer be inserted and tightened down. If the cover jams while it is being inserted, carefully remove it and try again. Never use the cover bolts to force the cover into position.

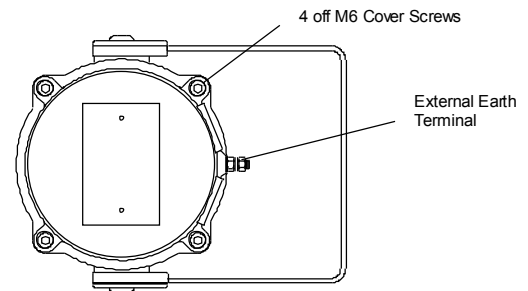

Figure 2

## 8) Power Supply Selection

It is important that a suitable power supply is used to run the beacons. The power supply selected must have the necessary capacity to provide the input current to all of the beacons connected to the system.

The following table shows the input current taken by the various units:-

Unit Type	Nominal I/P Voltage	Input Current	Max. I/P Volts
BExBG15D	24V DC	860mA	30V
BExBG15D	48V DC	480mA	58V
BExBG15D	230V AC	170mA	253V
BExBG15D	115V AC	360mA	126V
BExBG10D	12V DC	1.45A	15V
BExBG10D	24V DC	660mA	30V
BExBG10D	48V DC	340mA	58V
BExBG10D	230V AC	110mA	253V
BExBG10D	115V AC	250mA	126V

The input current will vary according to the voltage input level. The current levels shown above are for nominal input voltage. The 12V, 24V and 48V DC units have a converter circuit and therefore the input current level will decrease slightly as the input voltage is increased and will increase slightly as the input voltage is reduced.

The above table also shows the maximum voltages at which the beacons can be operated.

## 9) Cable Selection

When selecting the cable size consideration must be given to the input current that each unit draws (see table above), the number of beacons on the line and the length of the cable runs. The cable size selected must have the necessary capacity to provide the input current to all of the beacons connected to the line.

**SAFETY WARNING:** If the BExBG15D and BExBG10D beacons are used at high ambient temperatures, i.e. over +40°C, then the cable entry temperature may exceed +70°C and therefore suitable heat resisting cables must be used, with a rated service temperature of at least 110°C.

## 10) Earthing

Both AC and DC beacon units must be connected to a good quality earth. The units are provided with internal and external earthing terminals which are both located on the terminal chamber section of the unit (see figures 2 and 3).

When using the internal earth terminal ensure that the stainless steel M4 flat washer is between the incoming earth wire and the enclosure.

When using the external earth terminal a cable crimp lug must be used. The cable lug should be located between the two M5 stainless steel flat washers. The M5 stainless steel spring washer must be fixed between the outer flat washer and the M5 stainless steel nut to ensure that the cable lug is secured against loosening and twisting.

The internal earth bonding wire ensures that a good quality earth is maintained between the flameproof chamber casting and the flameproof cover casting.

### BExBG15D and BExBG10D Beacon Cover Internal

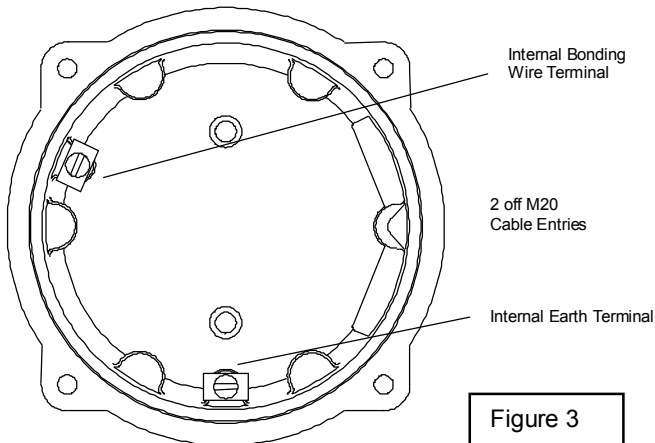

Figure 3

## 11) Cable Glands

The BExBG15D and BExBG10D beacons have dual cable gland entries which have an M20 x1.5 entry thread as standard. Only cable glands approved for Ex 'd' applications can be used, which must be suitable for the type of cable being used and also meet the requirements of the Ex 'd' flameproof installation standard EN60079-14:2008 / IEC60079-14:2007.

When only one cable entry is used the other one must be closed with an Ex 'd' flameproof blanking plug, which must be suitably approved for the installation requirements.

For combustible dust applications, the cable entry device and blanking elements shall be in type of explosion protection increased safety "e" or flameproof enclosure "d" and shall have an IP 6X rating according to EN60529:1992.

**SAFETY WARNING:** If the BExBG15D and BExBG10D beacons are used at high ambient temperatures, i.e. over +40°C, then the cable entry temperature may exceed +70°C and therefore suitable heat resisting cable glands must be used, with a rated service temperature of at least 110°C.

## 12) Cable Connections

The cable connections are made into the terminal blocks on the electronic pcb assembly located in the flameproof enclosure. See section 7 of this manual for access to the flameproof enclosure. A four-way terminal block is provided on both AC and DC beacons. Therefore there are two live terminals and two neutral terminals for the input and output wiring on AC units. On the DC units there are two +ve terminals and two -ve terminals for the input and output wiring.

### BExBG15D and BExBG10DD 15 and 10 Joule Beacons

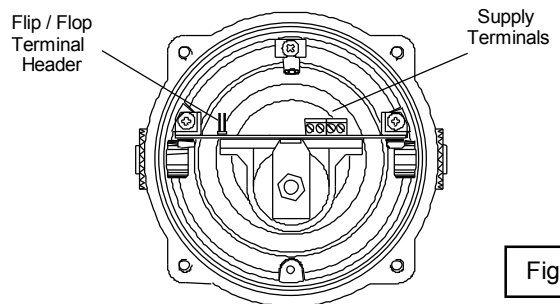

Figure 4

Wires having a cross sectional area of up to 2.5mm<sup>2</sup> can be connected to each terminal way. If an input and output wire is required a 2.5mm<sup>2</sup> wire can be connected to each terminal way. When connecting wires to the terminals great care should be taken to dress the wires so that when the cover is inserted into the chamber the wires do not exert excess pressure on the terminal blocks. This is particularly important when using cables with large cross sectional areas such as 2.5mm<sup>2</sup>.

### 13) Synchronised Operation

All BExBG15D and BExBG10D beacons that are connected to the same supply line will have a synchronised flash rate at one flash every second. To ensure that the units will be synchronised check that the pin header is not fitted, i.e. the two header pins are not shorted together (see Figure 4).

### 14) Flip-Flop Operation

Two beacons can be mounted close to each other to form a flip-flop operation, where the beacons will flash alternately. To achieve this mode of operation, fit a pin header to the flip-flop header pins on the electronics board, i.e. the two header pins are shorted together, (see figure 4) on one of the two beacons. The first flash on the beacon that has the header fitted will be delayed by  $\frac{1}{2}$  second. The two beacons will then flash alternately every  $\frac{1}{2}$  a second.

### 15) End of Line Monitoring (DC Units)

On the BExBG15D and BExBG10D DC beacons, dc reverse line monitoring can be used if required. All DC beacons have a blocking diode fitted in their supply input lines. An end of line monitoring diode or an end of line monitoring resistor can be connected across the +ve and -ve terminals. If an end of line resistor is used it must have a minimum resistance value of 3k3 ohms and a minimum wattage of 0.5 watts or a minimum resistance value of 500 ohms and a minimum wattage of 2 watts.

# INSTRUCTION MANUAL (ATEX / IECEx) (GBR)

## BExBG15D and BExBG10D

### Flameproof Xenon Beacons

#### For use in Flammable Gas and Dust Atmospheres

## 2) Marking

All units have a rating label, which carries the following important information:-

Unit Type No. BExBG15D or BExBG10D

Input Voltage: DC Units 24V or 48V or 12V (10J only)  
AC Units 230V or 115V

Codes: Ex d IIC T4 for Ta -50°C to +70°C  
Ex d IIC T5 for Ta -50°C to +40°C  
Ex tD A21 IP67 T125°C based on max. Ta of +70°C

Certificate No's KEMA 00ATEX2006  
IECEX KEM 10.0002

Epsilon x:  
Equipment Group and  
Category:

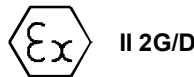

CE Marking  
Notified Body No.



**“Warnings”** DO NOT OPEN WHEN AN EXPLOSIVE  
GAS OR DUST ATMOSPHERE IS PRESENT

COVER BOLTS CLASS A4-80

USE HEAT RESISTING CABLES AND CABLE GLANDS  
(Rated 110°C) AT AMB. TEMPERATURES OVER 40°C

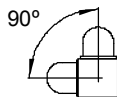

## 4) Installation Requirements

Beacons must be installed in accordance with the following or equivalent standards.

EN60079-14:2008 Electrical Installations in Hazardous  
IEC60079-14:2007 (Ed4) Areas (other than mines)  
EN60079-10:2003 Classification of Hazardous Areas  
IEC60079-10:2008 (Ed1)

Installation should only be carried by competent personnel  
and any local codes of practice applied.

## 5) Zones, Gas Group, Category and Temperature Classification

Area Classification:

Zone 1	Explosive gas air mixture likely to occur in normal operation.
Zone 2	Explosive gas air mixture not likely to occur, and if it does, it will only exist for a short time.

Gas Groupings:

Group IIA	Propane
Group IIB	Ethylene
Group IIC	Hydrogen and Acetylene

Temperature Classification:

T1	400°C
T2	300°C
T3	200°C
T4	135°C

T5	100°C	Amb. +40°C
----	-------	------------

Area Classification Dust:

Zone 21	Explosive dust air mixture likely to occur in normal operation.
Zone 22	Explosive dust air mixture not likely to occur, and if it does, it will only exist for a short time.

IP Rating IP67 T125°C Ta ≤ +70°C  
T110°C Ta ≤ +55°C  
T95°C Ta ≤ +40°C

Equipment Category: 2G/D

Ambient Temperature Range:

-50°C to +70°C  
(T5 = +40°C)

## 6) Beacon Location and Mounting

See drawing A

**SAFETY WARNING:** The BExBG15D and BExBG10D 15 and 10 joule beacons must be mounted with their flashdome in a position between upright and 90° as shown.

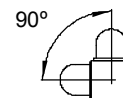

**SAFETY WARNING:** The flashdome guard must not be removed from the unit at any time.

## 7) Access to the Flameproof Enclosure

See drawing B

Note the four **M6 screws are Class A4-80 stainless steel and only screws of this category can be used on these beacons**. It is therefore important that these screws and their spring washers are kept in a safe place during installation.

## 8) Power Supply Selection

The system power supply must have the necessary capacity to provide the input current to all of the beacons connected to the system.

The following table shows the input current taken by the various units:-

Unit Type	Nominal I/P Voltage	Input Current	Max. I/P Volts
BExBG15D	24V DC	860mA	30V
BExBG15D	48V DC	480mA	58V
BExBG15D	230V AC	170mA	253V
BExBG15D	115V AC	360mA	126V
BExBG10D	12V DC	1.45A	15V
BExBG10D	24V DC	660mA	30V
BExBG10D	48V DC	340mA	58V
BExBG10D	230V AC	110mA	253V
BExBG10D	115V AC	250mA	126V

The above table also shows the maximum voltages at which the beacons can be operated.

## 9) Cable Selection

Cables must be capable of handling the current drawn from all of the units on the line.

**SAFETY WARNING:** If the BExBG15D and BExBG10D beacons are used at high ambient temperatures, i.e. over +40°C, then the cable entry temperature may exceed +70°C and therefore suitable heat resisting cables must be used, with a rated service temperature of at least 110°C.

## 10) Earthing

Both AC and DC beacon units must be connected to a good quality earth. The units are provided with internal and external earthing terminals which are both located on the terminal chamber section of the unit (see figures 2 and 3).

When using the internal earth terminal ensure that the stainless steel M4 flat washer is between the incoming earth wire and the enclosure.

When using the external earth terminal a cable crimp lug must be used. The cable lug should be located between the two M5 stainless steel flat washers. The M5 stainless steel spring washer must be fixed between the outer flat washer and the M5 stainless steel nut to ensure that the cable lug is secured against loosening and twisting.

The internal earth bonding wire ensures that a good quality earth is maintained between the flameproof chamber casting and the flameproof cover casting.

## 11) Cable Glands

The BExBG15D and BExBG10D beacons have dual cable gland entries which have an M20 x1.5 entry thread as

standard. Only cable glands approved for Ex 'd' applications can be used, which must be suitable for the type of cable being used and also meet the requirements of the Ex 'd' flameproof installation standard EN60079-14:2008 / IEC60079-14:2007.

When only one cable entry is used the other one must be closed with an Ex 'd' flameproof blanking plug, which must be suitably approved for the installation requirements.

For combustible dust applications, the cable entry device and blanking elements shall be in type of explosion protection increased safety "e" or flameproof enclosure "d" and shall have an IP 6X rating according to EN60529:1992.

**SAFETY WARNING:** If the BExBG15D and BExBG10D beacons are used at high ambient temperatures, i.e. over +40°C, then the cable entry temperature may exceed +70°C and therefore suitable heat resisting cable glands must be used, with a rated service temperature of at least 110°C.

## 12) Cable Connections

See drawings C and D / wiring diagram E

## 13) Synchronised Operation

All BExBG15D and BExBG10D beacons that are connected to the same supply line will have a synchronised flash rate at one flash every second. To ensure that the units will be synchronised check that the pin header is not fitted, i.e. the two header pins are not shorted together (see Figure 4).

## 14) Flip-Flop Operation

Two beacons can be mounted close to each other to form a flip-flop operation, where the beacons will flash alternately. To achieve this mode of operation, fit a pin header to the flip-flop header pins on the electronics board, i.e. the two header pins are shorted together, (see figure 4) on one of the two beacons. The first flash on the beacon that has the header fitted will be delayed by ½ second. The two beacons will then flash alternately every ½ a second.

## 15) End of Line Monitoring (DC Units)

On the BExBG15D and BExBG10D DC beacons, dc reverse line monitoring can be used if required. All DC beacons have a blocking diode fitted in their supply input lines. An end of line monitoring diode or an end of line monitoring resistor can be connected across the +ve and -ve terminals. If an end of line resistor is used it must have a minimum resistance value of 3k3 ohms and a minimum wattage of 0.5 watts or a minimum resistance value of 500 ohms and a minimum wattage of 2 watts.

## Drawing A

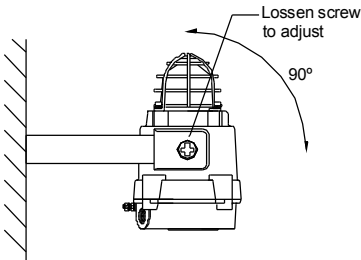
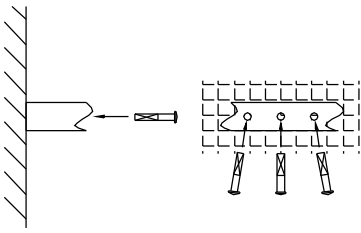

Loosen screw to adjust

90°

Loosen screw to adjust.  
 Løsn skruen for at tilpasse.  
 Schroef losdraaien om af te stellen.  
 Desserrer la vis pour régler.  
 Zum Regulieren Schraube lockern.  
 Allentare la vite per poter effettuare la regolazione.  
 Løsne skruen for å justere.  
 Desaperte o parafuso para ajustar.  
 Afloje el tornillo para ajustar.  
 Lossa skruven för att justera.

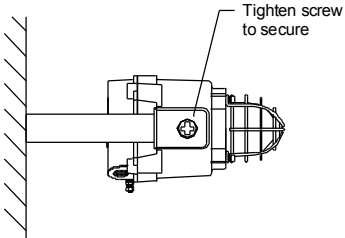

Tighten screw to secure

Tighten screw to secure.  
 Spænd skruen for at fastgøre.  
 Schroef aandraaien om vast te zetten.  
 Serrer la vis pour une fixation sûre.  
 Zum Sichern Schraube anziehen.  
 Stringere la vite per il fissaggio.  
 Stram skruen for å feste.  
 Aperte o parafuso para fixar.  
 Apriete el tornillo para asegurar.  
 Dra åt skruven för att fästa.

## Drawing B

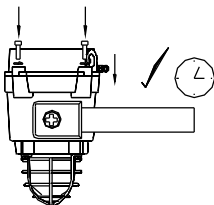
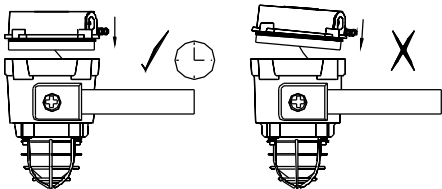
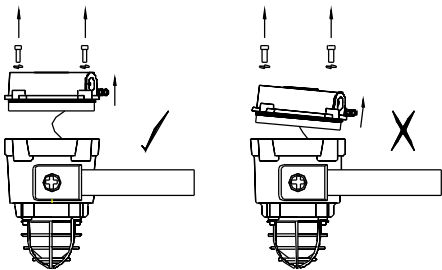

## Drawing C

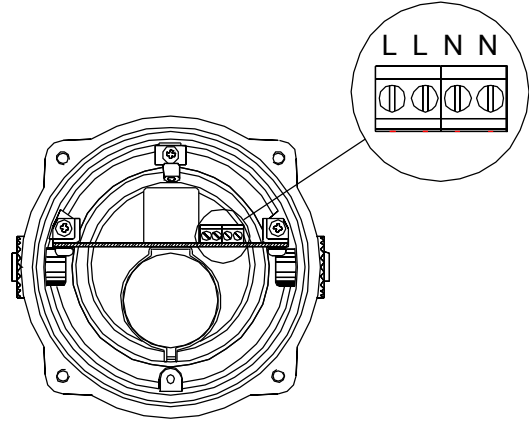

BExBG15D and  
 BExBG10D  
 AC units

## Drawing D

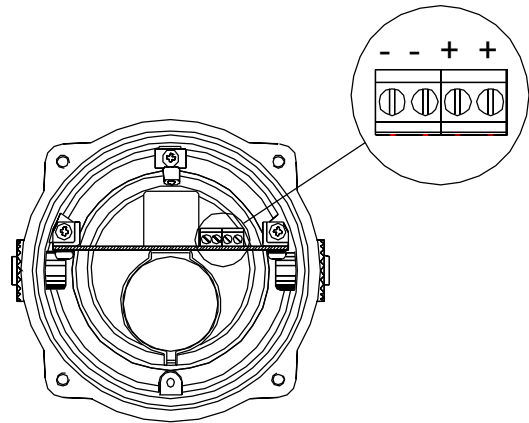

BExBG15D and  
 BExBG10D  
 DC units

## Wiring Diagram E

BExBG15D and  
BExBG10D  
AC Units

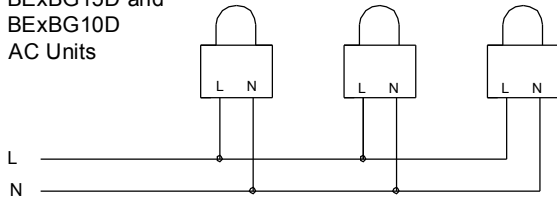

BExBG15D and  
BExBG10D  
DC Units

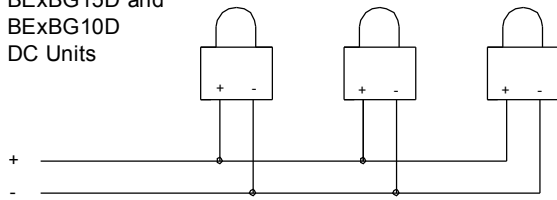



## 2) Mærkater

Alle enheder har en klassificeringsmærkat, der bærer følgende vigtige oplysninger:

Enhedstypenr. BExBG15D eller BExBG10D

Indgangsspænding:  
DC-enheder 48V eller 24V eller 12V (10J Only)  
AC-enheder 230V eller 115V

Kode: Ex d IIC T4 for Ta -50°C to +70°C  
Ex d IIC T5 for Ta -50°C to +40°C  
Ex tD A21 IP67 T125°C based on max. Ta of +70°C

Certifikatnr. KEMA 00ATEX2006  
IECEx KEM 10.0002

Epsilon x:  
Udstyrets gruppe  
og kategori:

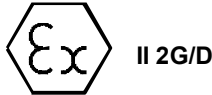

CE-mærke:  
Noteret myndighedsnr.

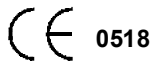

### "Advarsler"

MÅ IKKE ÅBNES,  
NÅR DER ER EKSPLOSIVE  
GASSER ELLER STØV TIL STEDE

DÆKBOLTE KLASSE A4-80

BRUG VARMEBESTANDIGE KABLER OG PAKDÅSER  
(Mærket 110°C) VED OMGIVENDE TEMP. OVER 40°C

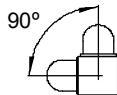

## 4) Installationskrav

Signaler skal installeres i overensstemmelse med følgende eller tilsvarende standarder.

EN60079-14:2008	Elektriske installationer i sundhedsfarlige områder (undtagen miner)
IEC60079-14:2007 (Ed4)	
EN60079-10:2003	Klassifikation af sundhedsfarlige områder
IEC60079-10:2008 (Ed1)	

Installation bør kun udføres af kompetent personale og under iagttagelse af lokale regler.

## 5) Zone-, gasgruppe-, kategori- og temperaturklassifikation

Enhederne kan installeres på områder med følgende forhold:

### Klassificeringsareal for gasser:

Zone 1	Eksplodiv gas- og luftblanding kan forekomme ved normal drift.
Zone 2	Eksplodiv gas- og luftblanding forekommer sandsynligvis ikke, og hvis det sker, vil det kun være for en kort tidsperiode.

### Gasgrupperinger:

Gruppe IIA	Propan
Gruppe IIB	Ethylen
Gruppe IIC	Hydrogen og acetylen

### Temperaturklassifikation:

T1	400° C
T2	300° C
T3	200° C
T4	135° C

T5	100° C	Amb. +40°C
----	--------	------------

### Klassificeringsareal for støv:

Zone 21	En eksplosiv blanding af støv og luft kan forekomme under den normale drift
Zone 22	En eksplosiv blanding af støv og luft vil sandsynligvis ikke forekomme, og hvis dette skulle ske, vil det kun vare et kort stykke tid.

**IP dimensionering:** IP67 T125°C Ta ≤ +70°C  
T110°C Ta ≤ +55°C  
T95°C Ta ≤ +40°C

**Udstyrskategori:** 2G/D

### Omgivende temperatur:

-50°C to +70°C  
(T5 = +40°C)

## 6) Placering og montering af signaler

Se illustration A

**SIKKERHEDSADVARSEL:** BExBG15D og BExBG10D 15-

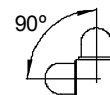

og 10-joules signaler skal monteres med lyshvælvingen i en position mellem opretstående stilling og en vinkel på 90° som vist.

**SIKKERHEDSADVARSEL:** Lyshvælvingen må aldrig afmonteres enheden.

## 7) Adgang til flammesikker indkapsling

Se illustration B

Bemærk, at de fire **M6 skruer er klasse A4-80, rustfri stål, og der må kun anvendes skruer af denne kategori på sounderne**. Det er derfor vigtigt, at skruerne og deres fjederskiver opbevares på et sikkert sted under installation.

## 8) Strømforsyning

Systemets strømforsyning skal have den nødvendige kapacitet for at kunne yde indgangsstrøm til alle signaler forbundet til systemet.

Nedenstående tabel viser indgangsstrømbehovet for forskellige signaler:

Enhedstype	Indgangsspænding	Indgangsstrøm	Maks. I/P Volt
BExBG15D	24V DC	860mA	30V
BExBG15D	48V DC	480mA	58V
BExBG15D	230V AC	170mA	253V
BExBG15D	115V AC	360mA	126V
BExBG10D	12V DC	1.45A	15V
BExBG10D	24V DC	660mA	30V
BExBG10D	48V DC	340mA	58V
BExBG10D	230V AC	110mA	253V
BExBG10D	115V AC	250mA	126V

Ovenstående tabel viser også maksimalspændingen, som sounderne kan betjenes ved.

## 9) Kabeludvalg

Kablerne skal kunne håndtere den samlede strøm fra alle anvendte enheder.

**SIKKERHEDSADVARSEL:** Hvis BExBG15D- og BExBG10D-signalerne anvendes ved høje omgivende temperaturer, dvs. + 40°C, kan kablets indgangstemperatur overstige +70°C, og der skal derfor anvendes passende varmebestandige kabler med en nominel arbejdstemperatur på mindst 110°C

## 10) Jordforbindelse

Både AC- og DC- signaler skal være forbundet til en jordforbindelse af høj kvalitet. Enhederne har indvendige og udvendige jordklemmer, der begge befinder sig på enhedens klemkammerdel (se figur 2 og 3).

Når den udvendige jordklemmel anvendes, skal der bruges en kabelklemmesko. Kabelskoen skal befinde sig mellem to flade M5-spændeskiver af rustfrit stål. De rustfrie stål M5-spændeskiver skal fastgøres mellem den ydre flade skive og M5-møtrikken af rustfrit stål for at sikre, at kabelskoen ikke løsner eller vrider sig.

## 11) Kabelafslutning

Signaler har dobbelte kabelafslutningsindgange med M20 x1,5 indgangsgevind. Kun kabelafslutninger godkendt til Ex 'd'-applikationer må anvendes og skal passe til den type

kabel, der anvendes samt opfylde kravene i Ex 'd', standard for flammesikker installation EN60079-14:2008 / IEC60079-14:2007.

Når der kun anvendes en kabelindgang, skal den anden lukkes med en Ex 'd', flammesikker blindprop, der skal være korrekt godkendt i overensstemmelse med installationskravene.

I forbindelse med letantændelige støvapplikationer skal kabelindføringsanordningen og stansningselementerne være med eksplosionsbeskyttelse for forhøjet sikkerhed af type "e" eller et flammesikkert indelukke af type "d" og skal have en IP 6X dimensionering i overensstemmelse med EN60529-1992.

**SIKKERHEDSADVARSEL:** Hvis BExBG15D- og BExBG10D-signalerne anvendes ved høje omgivende temperaturer, dvs. + 40°C, kan kablets indgangstemperatur overstige +70°C, og der skal derfor anvendes passende varmebestandige kabler med en nominel arbejdstemperatur på mindst 110°C

## 12) Kabelforbindelser

Se illustrationen C og D / ledningsdiagram E

## 13) Synkroniseret drift

Alle BExBG15D- og BExBG10D-signaler, der er forbundet til samme strømforsyning, har en synkroniseret blinkefrekvens på et blink pr. sekund. For at sikre, at enhederne er synkroniseret, skal det checkes, at pin headeren ikke er monteret, dvs. at de to header pins ikke er tilsluttet hinanden (se figur 4).

## 14) Bistabil drift

To signaler kan monteres tæt på hinanden for at danne en bistabil eller FF-drift, hvor signalerene blinker ude af takt med hinanden. For denne form for drift, skal der monteres en pin header på FF-headerne på kredsløbet, dvs. de to header forbindes (se figur 4) på én af de to signaler. Det første blink på det signal, hvorpå headeren er monteret forsinkes med ½ sekund. Derefter vil de to signaler blinke skiftevis hvert ½ sekund.

## 15) Linieslutovervågning (DC-enheder)

På BExBG15D og BExBG10D DC-enheder kan der anvendes returlinieovervågning, efter behov. Alle DC-soundere har en spærrediode i strømindgangsledningerne. En diode til linieslutovervågning eller en linieslutmodstand kan forbindes på tværs af +ve- og -ve- klemmerne. Hvis en linieslutmodstand anvendes, skal den have en minimum modstandsværdi på 3k3 ohm og et minimum watt-tal på 0,5 watt eller en minimum modstandsværdi på 500 ohm og et minimum watt-tal på 2 watt.

# INSTRUCTIEHANDLEIDING (ATEX / IECEx) (NLD)

## BExBG15D en BExBG10D

### Vuurvaste Xenon zwaailichten

#### Voor gebruik in brandbare gas- en stofatmosferen

## 2) Labels

Alle eenheden zijn voorzien van een label, waarop de volgende belangrijke informatie staat:

Typenr. eenheid: BExBG15D of BExBG10D

Ingangsspanning:  
DC-eenheden 48 V of 24 V of 12 V (10J only)  
AC-eenheden 230 V of 115 V

Code: Ex d IIC T4 for Ta -50°C to +70°C  
Ex d IIC T5 for Ta -50°C to +40°C  
Ex tD A21 IP67 T125°C based on max. Ta of +70°C

Certificaatnr. KEMA 00ATEX2006  
IECEX KEM 10.0002

Epsilon x:  
Groep en categorie  
van apparatuur:

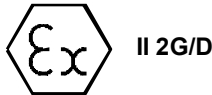

CE-certificaat:  
Instantiën.

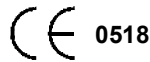

**“Waarschuwingen”** NIET OPENEN WANNEER  
ER EEN EXPLOSIEVE GAS-  
OF STOFATMOSFEER AANWEZIG IS  
  
DEKSELBOUTEN KLASSE A4-80

BIJ OMGEVINGSTEMP. HOGER DAN 40°C  
HITTEBESTENDIGE KABELS EN KABELWARTELS  
GEBRUIKEN (geschikt voor 110°C)

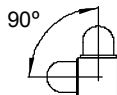

## 4) Vereisten voor installatie

Zwaailichten moeten worden geïnstalleerd in overeenstemming met de volgende of equivalente normen.

EN60079-14:2008 Elektrische installaties in gevaarlijke  
IEC60079-14:2007 (Ed4) omgevingen (anders dan mijnen)  
EN60079-10:2003 Classificatie van gevaarlijke  
IEC60079-10:2008 (Ed1) omgevingen

Installatie mag alleen worden uitgevoerd door deskundig personeel en met inachtneming van plaatselijke gedragscodes en praktijkrichtlijnen.

## 5) Classificatie t.a.v. zones, gasgroep, categorie en temperatuur

De eenheden kunnen worden geïnstalleerd op plaatsen waar de volgende omstandigheden heersen:

### Zoneclassificatie gas:

Zone 1	Ontpofbaar gas-/luchtmengsel is waarschijnlijk bij normaal bedrijf.
Zone 2	Ontpofbaar gas-/luchtmengsel is onwaarschijnlijk, en indien dit ontstaat zal het waarschijnlijk slechts korte tijd aanwezig blijven.

### Gasgroeperingen:

Groep IIA	Propana
Groep IIB	Ethyleen
Groep IIC	Waterstof en acetyleen

### Temperatuurclassificatie:

T1	400°C
T2	300°C
T3	200°C
T4	135°C

T5	100°C	Amb. +40°C
----	-------	------------

### Zoneclassificatie stof:

Zone 21	Explosief stof-luchtmengsel waarschijnlijk aanwezig bij normaal functioneren.
Zone 22	Explosief stof-luchtmengsel waarschijnlijk niet aanwezig, of alleen van korte duur.

**IP-classificatie:** IP67 T125°C Ta ≤ +70°C  
T110°C Ta ≤ +55°C  
T95°C Ta ≤ +40°C

**Categorie van apparatuur:** 2G/D

### Omgevingstemperatuur:

-50°C to +70°C  
(T5 = +40°C)

## 6) Plaatsen en bevestigen van zwaailicht

Zie tekening A

**VEILIGHEIDSWAARSCHUWING:** de BExBG15D en BExBG10D 15 en 10 joule zwaailichten dienen zoals afgebeeld te worden bevestigd met de bolle kap van het zwaailicht in een stand tussen rechtop en 90°.



**VEILIGHEIDSWAARSCHUWING:** de bescherming van de bolle kap van het zwaailicht mag nooit van de eenheid worden verwijderd.

## 7) Toegang tot de vuurvaste behuizing

Zie tekening B

Houdt u er rekening mee dat de vier **M6-schroeven van Klasse A4-80 roestvrij staal zijn en dat op deze alarmgevers alleen schroeven van deze categorie kunnen worden gebruikt.** Het is derhalve belangrijk dat deze schroeven en de bijbehorende veeringen tijdens de installatie op een veilige plaats worden bewaard.

## 8) Kiezen van voedingsbron

De voedingsbron van het systeem dient voldoende capaciteit te hebben om alle zwaailichten die op het systeem zijn aangesloten van elektrische voeding te voorzien.

In de onderstaande tabel staat vermeld welke ingangsstroom de verschillende zwaailichten trekken:

Type eenheid	Ingangsspanning	Ingangsstroom	Max. I/P volt
BExBG15D	24V DC	860mA	30V
BExBG15D	48V DC	480mA	58V
BExBG15D	230V AC	170mA	253V
BExBG15D	115V AC	360mA	126V
BExBG10D	12V DC	1.45A	15V
BExBG10D	24V DC	660mA	30V
BExBG10D	48V DC	340mA	58V
BExBG10D	230V AC	110mA	253V
BExBG10D	115V AC	250mA	126V

In de bovenstaande tabel wordt tevens vermeld op welke maximumspanningen de zwaailichten kunnen werken.

## 9) Kiezen van kabels

Kabels moeten bestand zijn tegen de stroom die door alle eenheden op de lijn wordt getrokken.

**VEILIGHEIDSWAARSCHUWING:** als de BExBG15D en BExBG10D zwaailichten worden gebruikt bij hoge omgevingstemperaturen, m.a.w. meer dan +40° C, dan kan de temperatuur bij de kabelingang hoger zijn dan +70°C en moeten dus geschikte hittebestendige kabels worden gebruikt, met een nominale werktemperatuur van ten minste 110° C.

## 10) Aarding

Zowel zwaailichten op wisselstroom als gelijkstroom moeten worden aangesloten op aarding van goede kwaliteit. De eenheden worden geleverd met interne en externe aardaansluitingen, beide aangebracht op het gedeelte met de aansluitkast op de eenheid (zie Afb. 2 en 3).

Bij gebruik van de externe aardaansluiting dient een kabelkrimpous te worden gebruikt. De kabelous moet worden aangebracht tussen de twee M5 roestvrijstalen platte borgschijfjes. De M5 roestvrijstalen veering moet worden bevestigd tussen het buitenste platte borgschijfje en de M5 roestvrijstalen moer, zodat de kabelous goed is vastgezet en niet kan draaien of losraken.

## 11) Kabelwartels

De zwaailichten zijn voorzien van dubbele kabelwartelingen met M20 x 1,5 ingangsschroefdraad. Er kunnen alleen kabelwartels worden gebruikt die zijn goedgekeurd voor Ex 'd'-toepassingen, geschikt zijn voor het bekabelingstype dat wordt gebruikt en voldoen aan de vereisten van de norm EN60079-14:2008 / IEC60079-14:2007 ten aanzien van de Ex 'd' vuurvaste installatie.

Indien slechts een kabelingang wordt gebruikt, dient de andere te worden afgesloten met een Ex 'd' vuurvaste afdichtplug, die moet zijn goedgekeurd voor de installatievereisten.

Voor brandbare stoftoepassingen zullen de kabelinvoer en blokkeerelementen van het type explosiebescherming met verhoogde beveiliging "e" of vuurvaste omhulling "d" zijn en een IP 6X-classificatie hebben overeenkomstig EN60529:1992.

**VEILIGHEIDSWAARSCHUWING:** als de BExBG15D en BExBG10D zwaailichten worden gebruikt bij hoge omgevingstemperaturen, m.a.w. meer dan +40° C, dan kan de temperatuur bij de kabelingang hoger zijn dan +70°C en moeten dus geschikte hittebestendige kabels worden gebruikt, met een nominale werktemperatuur van ten minste 110° C.

## 12) Kabelaanluitingen

Zie tekening C en D / bedradingsschema E

## 13) Gesynchroniseerde werking

Alle BExBG15D en BExBG10D zwaailichten die op dezelfde voedingslijn zijn aangesloten, knipperen gesynchroniseerd eenmaal per seconde. Om zeker te stellen dat de eenheden gesynchroniseerd zijn, controleert u dat het pinvoetje niet is gemonteerd, m.a.w. de twee pinnen zijn niet kortgesloten (zie Afb. 4).

## 14) Flip-flop werking

Als flip-flop werking vereist is, waarbij de zwaailichten om beurten knipperen, kunnen twee zwaailichten dicht bij elkaar worden gemonteerd. Voor deze werkingsmodus dient een pinvoetje op de flip-flop pinnen op het elektronisch paneel te worden aangebracht, m.a.w. de twee pinnen zijn op een van de twee zwaailichten kortgesloten (zie Afb. 4). De eerste flits van het zwaailicht waarop het voetje is gemonteerd, wordt ½ seconde vertraagd. Daarna knipperen de twee zwaailichten om beurten elke ½ seconde.

## 15) Bewaking aan einde van lijn (DC-eenheden)

Op BExBG15D en BExBG10D DC-eenheden kan desgewenst omgekeerde gelijkstroomlijnbewaking worden gebruikt. Alle DC- zwaailichten zijn uitgerust met een blokkeringsdiode in de inganglijnen voor de elektrische voeding. Een bewakingsdiode of bewakingsweerstand aan het einde van de lijn kan worden aangesloten op de +ve en -ve contacten. Indien een weerstand aan het einde van de lijn wordt gebruikt, dient deze een minimumweerstandswaarde van 3k3 ohm en een minimumwattage van 0,5 watt te hebben, of een minimumweerstandswaarde van 500 ohm en een minimumwattage van 2 watt.

## 2) Marquage

Les caractéristiques nominales de toutes les unités figurent sur une étiquette comportant les informations importantes suivantes :

N° de type d'unité : BExBG15D ou BExBG10D

Tension d'entrée : Unités CC 48 V, 24 V ou 12V (10J only)  
Unités CA 230 V ou 115 V

Code: Ex d IIC T4 for Ta -50°C to +70°C  
Ex d IIC T5 for Ta -50°C to +40°C  
Ex tD A21 IP67 T125°C based on max. Ta of +70°C

N° certificat : KEMA 00ATEX2006  
IECEx KEM 10.0002

Epsilon x :  
Groupe et classe  
de l'équipement :

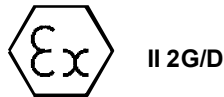

Marquage CE :  
N° de l'organisme



**Avertissements** NE PAS OUVRIR EN PRESENCE D'UN GAZ  
EXPLOSIF OU DANS UNE ATMOSPHERE  
POUSSIÉREUSE

BOULONS DE COUVERCLE DE CLASSE A4-80

UTILISER DES CABLES ET DES PRESSE-ETOUPE  
RESISTANTS A LA CHALEUR (Valeur nominale 95°C)  
A DES TEMPERATURES AMBIANTES  
SUPERIEURES A 40°C

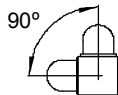

## 4) Spécifications d'installation

Les balises doivent être installées selon les normes suivantes, ou des équivalents.

EN60079-14:20008 Installations électriques dans des  
IEC60079-14:2007 (Ed4) zones dangereuses (autres que des  
mines)  
EN60079-10:2003 Classification des zones dangereuses  
IEC60079-10:2008 (Ed1)

L'installation doit être effectuée uniquement par un personnel compétent et conformément aux codes de pratique locaux.

## 5) Classification des zones, du groupe et de la catégorie de gaz et des températures

Les unités peuvent être installées dans des endroits respectant les conditions suivantes :

### Classification de zone : gaz:

Zone 1	Mélange d'air et de gaz explosif pouvant survenir en condition normale.
Zone 2	Mélange d'air et de gaz explosif ne pouvant pas survenir et qui, dans le cas contraire, serait présent que très brièvement.

### Groupes de gaz :

Groupe IIA	Propane
Groupe IIB	Ethylène
Groupe IIC	Hydrogène et Acétylène

### Plage de températures ambiantes :

T1	400° C
T2	300° C
T3	200° C
T4	135° C

T5	100° C	Amb. +40°C
----	--------	------------

### Classification des zones : poussière :

Zone 21	Mélange air-poussière explosif susceptible de se former durant le cours normal des opérations
Zone 22	Mélange air-poussière explosif non susceptible de se former et qui, s'il se forme, ne subsistera pas longtemps.

Indice IP : IP67 T125°C Ta ≤ +70°C  
T110°C Ta ≤ +55°C  
T95°C Ta ≤ +40°C

Classe de l'équipement: 2G/D

### Plage de températures ambiantes :

-50°C to +70°C  
(T5 = +40°C)

## 6) Assemblage et emplacement de la balise

Se reporter au schéma A

**AVERTISSEMENT DE SECURITE :** les balises BExBG15D et BExBG10D de 15 et 10 joules doivent être installées avec le dôme lumineux situé entre 90° et la verticale, comme illustré.

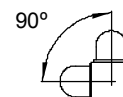

**AVERTISSEMENT DE SECURITE :** la protection du dôme lumineux ne doit jamais être enlevée de l'unité.

## 7) Accès au boîtier antidéflagrant

Se reporter au schéma B

Remarque : les quatre vis M6 sont en acier inoxydable de classe A4-80 et seules des vis de ce type doivent être utilisées sur ces alarmes sonores. C'est pourquoi il est important de les conserver, ainsi que leurs rondelles à ressort, en un endroit sûr pendant l'installation.

## 8) Sélection de l'alimentation électrique

L'alimentation électrique du système doit posséder la capacité nécessaire pour procurer le courant d'entrée à toutes les balises connectées au système.

Le tableau suivant indique le courant d'entrée pour les diverses balises :

Type d'unité	Tension d'entrée	Courant d'entrée	Volts I/P max.
BExBG15D	24V DC	860mA	30V
BExBG15D	48V DC	480mA	58V
BExBG15D	230V AC	170mA	253V
BExBG15D	115V AC	360mA	126V
BExBG10D	12V DC	1.45A	15V
BExBG10D	24V DC	660mA	30V
BExBG10D	48V DC	340mA	58V
BExBG10D	230V AC	110mA	253V
BExBG10D	115V AC	250mA	126V

Le tableau ci-dessus indique également les tensions maximales de fonctionnement des alarmes sonores.

## 9) Sélection des câbles

Les câbles doivent pouvoir prendre en charge le courant utilisé par toutes les unités sur la ligne.

**AVERTISSEMENT DE SECURITE :** si les balises BExBG15D et BExBG10D sont utilisées à des températures ambiantes élevées, c'est-à-dire supérieures à +40°C, la température d'entrée du câble peut excéder +70°C. Des câbles résistants à la chaleur, d'une température de service assignée de 110°C minimum, doivent donc être utilisés.

## 10) Mise à la terre

Les unités balises CA et CC doivent être connectées à un système de mise à la terre de bonne qualité. Les unités sont fournies avec des bornes de mise à la terre externe et interne qui sont toutes les deux situées sur la section de chambre terminale de l'unité (se reporter aux figures 2 et 3).

Lors de l'utilisation de la borne de mise à la terre externe, employer une cosse à sertir. La cosse à sertir doit être située entre les deux rondelles plates M5 en acier inoxydable. La rondelle à ressort M5 en acier inoxydable doit être fixée entre la rondelle plate externe et l'écrou M5 en acier inoxydable afin que la cosse à sertir ne se desserre ni ne se torde.

## 11) Presse-étoupe

Les balises ont deux entrées de presse-étoupe avec des filetages d'entrée M20 x1,5. Seuls les presse-étoupe approuvés pour les applications Ex 'd' peuvent être utilisés, et ils doivent être adéquats pour le type de câble utilisé et répondre aux exigences d'installation d'antidéflagrant Ex 'd' de norme EN60079-14:2008 / IEC60079-14:2007.

Lorsqu'une seule entrée de câble est utilisée, un bouchon obturateur antidéflagrant Ex 'd', répondant aux exigences d'installation, doit être appliqué sur l'autre entrée.

Pour les applications avec présence de poussière combustible, le dispositif d'entrée de câble et les obturateurs requièrent un type de protection antidéflagrante accrue « e » ou un boîtier ignifugé « d » et doivent présenter un indice de protection IP 6X conforme à EN60529 :1992

**AVERTISSEMENT DE SECURITE :** si les balises BExBG15D et BExBG10D sont utilisées à des températures ambiantes élevées, c'est-à-dire supérieures à +40°C, la température d'entrée du câble peut excéder +70°C. Des câbles résistants à la chaleur, d'une température de service assignée de 110°C minimum, doivent donc être utilisés.

## 12) Connexions de câble

Se reporter au schéma C et D / de câblage E

## 13) Fonctionnement synchronisé

Toutes les balises BExBG15D et BExBG10D qui sont connectées sur la même alimentation possèdent un taux de clignotement synchronisé de un clignotement/seconde. Afin de s'assurer que les unités seront synchronisées, vérifier que la barrette mâle n'est pas installée, c'est-à-dire que les deux barrettes mâles ne sont pas en court-circuit (voir Figure 4).

## 14) Fonctionnement en bascule

Deux balises peuvent être installées proches l'une de l'autre pour créer un fonctionnement en bascule où les balises clignotent alternativement. Pour obtenir ce mode de fonctionnement, installer une barrette mâle sur les barrettes du système en bascule sur le tableau de commande, c'est-à-dire que les barrettes sont en court-circuit (voir figure 4) sur l'une des deux balises. Le premier clignotement sur la balise sur laquelle la barrette est installée sera retardé de ½ seconde. Les deux balises clignoteront alors alternativement toutes les ½ secondes.

## 15) Contrôle de fin de ligne (Unités CC)

Sur les unités CC BExBG15D et BExBG10D, un contrôle de ligne inverse cc peut être utilisé si nécessaire. Toutes les balises CC possèdent une diode de blocage installée sur leur ligne d'entrée d'alimentation. Une diode de contrôle de fin de ligne ou une résistance de contrôle de fin de ligne peut être connectée sur les bornes positive et négative. En cas d'utilisation d'une résistance de fin de ligne, celle-ci doit avoir une valeur de résistance minimum de 3k3 ohms et une puissance minimum de 0,5 watt ou une résistance minimum de 500 ohms ainsi qu'une puissance minimum de 2 watts.

# TECHNISCHE HINWEISE (ATEX / IECEx) (DEU)

## BExBG15D und BExBG10D

### Explosiongeschützte Xenon-Baken

### Zum Einsatz in entflammbaren Gas- und Staubatmosphären

#### 2) Kennzeichnung

Alle Geräte sind mit einem Typenschild mit den folgenden wichtigen Informationen versehen:-

Gerätetyp-Nr. BExBG15D oder BExBG10D

Eingangsspannung:

Gleichstromgeräte (DC) 48V, 24V oder 12V (10J only)  
Wechselstromgeräte (AC) 230V oder 115V

Code: Ex d IIC T4 for Ta -50°C to +70°C  
Ex d IIC T5 for Ta -50°C to +40°C  
Ex tD A21 IP67 T125°C based on max. Ta of +70°C

Zertifikat-Nr. KEMA 00ATEX2006  
IECEX KEM 10.0002

Epsilon x:  
Gerätegruppe und  
-kategorie:

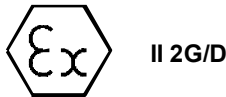

CE-Kennzeichnung:/  
Bekannt gegebene



#### Warnung

NICHT IN EXPLOSIONSFÄHIGEN GAS- ODER STAUBATMOSPHEREN ÖFFNEN

ABDECKSCHRAUBEN KLASSE A4-80

WÄRMEBESTÄNDIGE KABEL UND KABELFLANSCHEN VERWENDEN  
(Nennleistung 110°C) BEI UMGEB.-TEMP. ÜBER 40°C

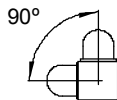

#### 4) Installationsanforderungen

Die Baken müssen gemäß den folgenden oder vergleichbaren Standards installiert werden.

EN60079-14:2008 Elektrische Installationen in Gefahrenbereichen (außer Bergwerken)  
IEC60079-14:2007 (Ed4)

EN60079-10:2003 Klassifizierung von Gefahrenbereichen  
IEC60079-10:2008 (Ed1)

Die Installation sollte nur von qualifiziertem Fachpersonal vorgenommen werden. Örtliche anerkannte Verfahren sind zu beachten.

#### 5) Zonen, Gasgruppe, Kategorie und Temperaturklassifizierung

Die Geräte können an Standorten aufgestellt werden, an denen die folgenden Bedingungen vorliegen:-

#### Bereichseinteilung Gas:

Zone 1	Bei normalem Betrieb kann mit hoher Wahrscheinlichkeit eine explosive Gas-Luft-Mischung vorliegen.
Zone 2	Explosive Gas-Luft-Mischung unwahrscheinlich und sollte sie doch auftreten, dann nur kurzfristig.

#### Gasgruppen:

Gruppe IIA	Propan
Gruppe IIB	Äthylen
Gruppe IIC	Wasserstoff und Azetylen

#### Temperaturklassifizierung:

T1	400°C
T2	300°C
T3	200°C
T4	135°C

T5	100°C	Amb. +40°C
----	-------	------------

#### Bereichseinteilung Staub:

Zone 21	Explosionsgefährdetes Staub-/Luftgemisch, das beim normalen Betrieb durchaus auftreten kann
Zone 22	Explosionsgefährdetes Staub-/Luftgemisch, dessen Auftreten unwahrscheinlich bzw. von kurzer Dauer ist.

IP-Schutzklasse: IP67 T125°C Ta ≤ +70°C  
T110°C Ta ≤ +55°C  
T95°C Ta ≤ +40°C

Geräte-kategorie: 2G/D

#### Umgebungstemperaturbereich:

-50°C to +70°C  
(T5 = +40°C)

#### 6) Standort und Montage der Baken

Siehe Zeichnung A

**SICHERHEITSHINWEIS:** Die Baken BExBG15D und BExBG10D (15 bzw. 10 Joule) müssen so montiert werden, dass die Signalhaube zwischen senkrecht und einem Winkel von 90° montiert ist (siehe Abbildung).

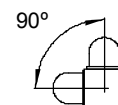

**SICHERHEITSHINWEIS:** Der Schutz der Signalhaube darf auf keinen Fall vom Gerät entfernt werden.

## 7) Zugang zum schwer entflammaren Gehäuse

Siehe Zeichnung B

Hinweis: Die vier **Schrauben M6 sind aus Edelstahl Klasse A4-80 gefertigt. Für diese Sounder sind nur Schrauben dieser Kategorie geeignet.** Diese Schrauben und die zugehörigen Federringe sind beim Einbau daher sorgfältig aufzubewahren.

## 8) Stromversorgung

Die Stromversorgung der Anlage muss ausreichen, um alle angeschlossenen Baken mit Eingangsstrom zu versorgen.

Folgende Tabelle zeigt die Eingangsstromaufnahme der verschiedenen Baken:-

Gerätetyp	Eingangsspannung	Eingangsstrom	Max. I/P Spannung
BExBG15D	24V DC	860mA	30V
BExBG15D	48V DC	480mA	58V
BExBG15D	230V AC	170mA	253V
BExBG15D	115V AC	360mA	126V
BExBG10D	12V DC	1.45A	15V
BExBG10D	24V DC	660mA	30V
BExBG10D	48V DC	340mA	58V
BExBG10D	230V AC	110mA	253V
BExBG10D	115V AC	250mA	126V

Obige Tabelle zeigt auch die maximale Spannung an, mit der die Baken betrieben werden können.

## 9) Kabelwahl

Die Kabel müssen den Strom aller angeschlossenen Geräte führen können.

**SICHERHEITSHINWEIS:** Wenn die Baken BExBG15D und BExBG10D bei hohen Umgebungstemperaturen eingesetzt werden (d. h. bei über +40°C), kann die Kabeleingangstemperatur +70°C übersteigen. Daher sind geeignete hitzebeständige Kabel mit einer Nennbetriebstemperatur von mindestens 110°C zu verwenden.

## 10) Erdung

Die Wechsel- und Gleichstrom-Bakengeräte müssen mit einer hochwertigen Erdung verbunden werden. Die Geräte sind mit internen und externen Erdklemmen (am Klemmkammerteil des Geräts, siehe Abb. 2 und 3) versehen.

Bei Verwendung der externen Erdklemme ist ein Quetschkabelschuh zu verwenden, der zwischen den beiden flachen M5-Edelstahl-Unterlegscheiben eingesetzt werden sollte. Die M5-Unterlegscheiben sind zwischen der äußeren flachen Unterlegscheibe und der M5-Edelstahlmutter einzusetzen, um zu gewährleisten, dass der Kabelschuh sich nicht lösen oder verdrehen kann.

## 11) Cable Glands

Die Baken sind mit doppelten Kabelflanscheingängen mit Eingangsgewinden von M20 x1.5 versehen. Es dürfen nur Kabelflansche verwendet werden, die für Ex 'd'-

Anwendungen zugelassen sind. Die Kabelflansche müssen für den eingesetzten Kabeltyp geeignet sein und zudem den Anforderungen der Ex 'd'-Norm zur Installation schwer entflammbarer Geräte EN60079-14:2008 / IEC60079-14:2007 entsprechen.

Wenn nur ein Kabeleingang verwendet wird, muss der andere mit einem schwer entflammaren Ex 'd' Handlochverschluss, der für die Installationsbedingungen zugelassen ist, verschlossen werden.

Bei Anwendungen in brennbaren Staubbereichen sind der Kabelanschluss und die Abdeckelemente in einem Gehäuse mit erhöhtem Explosionsschutz (Typ „e“) oder erhöhtem Entflammbarkeitsschutz („Typ „d“) zu installieren und müssen der Schutzklasse IP 6X gemäß EN60529:1992 entsprechen.

**SICHERHEITSHINWEIS:** Wenn die Baken BExBG15D und BExBG10D bei hohen Umgebungstemperaturen eingesetzt werden (d. h. bei über +40°C), kann die Kabeleingangstemperatur +70°C übersteigen. Daher sind geeignete hitzebeständige Kabel mit einer Nennbetriebstemperatur von mindestens 110°C zu verwenden.

## 12) Kabelanschlüsse

Siehe Zeichnung Cog D / Schaltbild E

## 13) Synchroner Betrieb

Alle Baken BExBG15D und BExBG10D, die an die gleiche Speiseleitung angeschlossen sind, operieren mit synchroner Signalrate von einem Signal pro Sekunde. Um den synchronen Betrieb der Geräte sicherzustellen, vergewissern Sie sich, dass kein Stiftsockel angebracht ist, d. h. dass die beiden Sockelstifte nicht zusammen verkürzt sind (siehe Abb. 4).

## 14) Flipflop-Betrieb

Um den Flipflop-Betrieb, d. h. ein abwechselndes Aufblinker der Baken, zu gewährleisten, können zwei Baken dicht nebeneinander montiert werden. Dazu setzen Sie einen Stiftsockel auf die Flipflop-Sockelstifte der Platine, d. h. verkürzen Sie die beiden Sockelstifte an einer Bake zusammen (siehe Abb. 4). Das erste Signal der mit dem Sockel versehenen Bake wird um ½ Sekunde verzögert. Die beiden Baken blinken daraufhin abwechselnd jede ½ Sekunde auf.

## 15) Überwachung des Leitungsendes (Gleichstromgeräte)

Bei BExBG15D- und BExBG10D-Gleichstromgeräten kann bei Bedarf eine Wechselstrom-Sperrleitungs kontrolle eingesetzt werden. Alle Gleichstrom-Baken sind mit einer Sperrdiode versehen, die in die Speise-Eingangsleitungen eingesetzt ist. Eine Überwachungsdiode oder ein Kontrollwiderstand für das Leitungsende können über die Klemmen +ve und -ve miteinander verbunden werden. Wird ein Widerstand für das Leitungsende verwendet, muss sein Widerstandswert mindestens 3k3 Ohm und die Mindestleistung 0,5 Watt betragen, oder aber es muss ein Widerstandswert von mindestens 500 Ohm und eine Mindestleistung von 2 Watt vorliegen.



## 2) Marchio

Tutte le unità sono dotate di etichetta contenente le seguenti importanti informazioni:-

N. tipo unità **BExBG15D o BExBG10D**

Tensione in ingresso:  
 Unità CC 48 V o 24 V o 12 V (10J only)  
 Unità CA 230 V o 115 V

Codice: Ex d IIC T4 for Ta -50°C to +70°C  
 Ex d IIC T5 for Ta -50°C to +40°C  
 Ex tD A21 IP67 T125°C based on max. Ta of +70°C

N. certificato **KEMA 00ATEX2006**  
**IECEX KEM 10.0002**

Epsilon x:  
 Gruppo e categoria apparecchiatura:

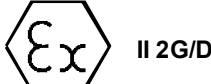

Marchio CE:  
 N. notifica



**“Attenzione”** NON APRIRE IN CASO DI PRESENZA DI GAS O POLVERI ESPLOSIVE

COPRIRE I BULLONI CON UNA COPERTURA CLASSE A4-80

USARE CAVI E PREMISTOPPA PER CAVI RESISTENTI AL CALORE (temp. nominale 110°C) SE LA TEMPERATURA AMB. È SUPERIORE A 40°C

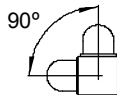

## 4) Requisiti di installazione

Le lampeggiatori devono essere installate in conformità con i seguenti standard o standard equivalenti.

EN60079-14:2008 Installazioni elettriche in aree pericolose (tranne che nelle miniere)  
 IEC60079-14:2007 (Ed4)  
 EN60079-10:2003 Classificazione delle aree pericolose  
 IEC60079-10:2008 (Ed1)

L'installazione deve essere eseguita da personale competente e devono essere applicati tutti i codici professionali I °Cali.

## 5) Classificazione delle zone, dei gruppi di gas, delle categorie e delle temperature

Le unità possono essere installate in ambienti che presentano le seguenti condizioni:-

### Classificazione area Gas:

Zona 1	È probabile la presenza di gas esplosivo durante il normale funzionamento.
Zona 2	Non è probabile che sia presente gas esplosivo, e se esso dovesse essere presente, potrà esserlo solo per un breve periodo di tempo.

### Gruppi di gas:

Gruppo IIA	Propano
Gruppo IIB	Etilene
Gruppo IIC	Idrogeno e Acetilene

### Classificazione delle temperature:

T1	400° C
T2	300° C
T3	200° C
T4	135° C

T5	100° C	Amb. +40°C
----	--------	------------

### Classificazione area Polvere:

Zona 21	Probabile formazione di miscele esplosive polvere/aria durante il normale funzionamento.
Zona 22	Improbabile formazione, eventualmente solo temporanea, di miscele esplosive polvere/aria.

**Classificazione IP:** IP67 T125°C Ta ≤ +70°C  
 T110°C Ta ≤ +55°C  
 T95°C Ta ≤ +40°C

**Categoria apparecchiatura:** 2G/D

### Intervallo della temperatura ambientale:

-50°C to +70°C  
 (T5 = +40°C)

## 6) Collocazione ed installazione del lampeggiatore

Vedere figura A

**AVVERTENZE DI SICUREZZA:** i lampeggiatori BExBG15D e BExBG10D da 15 e 10 joule devono essere installati con la protezione dell'apparato lampeggiante in una posizione compresa tra quella verticale e quella di 90°, come illustrato.

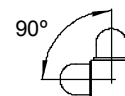

**AVVERTENZE DI SICUREZZA:** la protezione dell'apparato lampeggiante non deve mai essere rimossa dal dispositivo.

## 7) Accesso al sistema antincendio

Vedere figura B

Le quattro viti M6 sono in acciaio inossidabile classe A4-80; su queste sirene possono essere usate solo viti di questa categoria. Quindi è importante che queste viti e le relative rondelle a molla siano conservate in un luogo sicuro durante l'installazione.

## 8) Selezione dell'alimentazione elettrica

Il sistema di alimentazione elettrica deve avere la capacità adeguata a fornire la corrente di ingresso a tutti i lampeggiatori collegati al sistema.

Le seguenti tabelle indicano la corrente di ingresso assorbita dai diversi lampeggiatori:-

Tipo unità	Tensione in ingresso	Corrente in ingresso	Volt I/P max.
BExBG15D	24V DC	860mA	30V
BExBG15D	48V DC	480mA	58V
BExBG15D	230V AC	170mA	253V
BExBG15D	115V AC	360mA	126V
BExBG10D	12V DC	1.45A	15V
BExBG10D	24V DC	660mA	30V
BExBG10D	48V DC	340mA	58V
BExBG10D	230V AC	110mA	253V
BExBG10D	115V AC	250mA	126V

La tabella sopra riportata mostra inoltre le tensioni massime previste per il funzionamento delle lampeggiatori.

## 9) Scelta dei cavi

I cavi devono essere capaci di sostenere la corrente proveniente da tutte le unità presenti sulla linea.

**AVVERTENZE DI SICUREZZA:** qualora i lampeggiatori BExBG15D e BExBG10D siano utilizzati ad elevate temperature ambiente, ad es. oltre +40°C, la temperatura dei cavi di entrata può superare +70°C; si devono pertanto impiegare cavi adeguati resistenti al calore, dalla temperatura nominale di servizio di almeno 110°C.

## 10) Collegamento di terra

Sia le unità lampeggiatori CA sia quelle CC devono essere collegate correttamente a terra. Le unità vengono fornite con morsetti di collegamento a terra interni ed esterni, entrambi situati sulla morsettiera dell'unità (vedere figure 2 e 3).

Quando si utilizza il morsetto di collegamento a terra esterno, occorre utilizzare un capocorda aggraffato per cavi. Il capocorda deve essere posto tra due rondelle piatte in acciaio inossidabile M5. La rondella a molla in acciaio inossidabile M5 deve essere fissata tra la rondella piatta esterna e il dado in acciaio inossidabile M5, in modo da garantire che il capocorda sia fissato saldamente e che quindi non possa allentarsi o attorcigliarsi.

## 11) Premistoppa per cavi

Le lampeggiatori sono dotate di due ingressi per premistoppa con filettature M20 x1.5. Utilizzare solo premistoppa approvati per le applicazioni Ex 'd'; essi inoltre devono essere adeguati al tipo di cavo in uso e devono rispettare gli

standard di installazione antincendio Ex 'd' EN60079-14:2008 / IEC60079-14:2007.

Quando si utilizza solo un ingresso per cavi, l'altro ingresso deve essere chiuso con un maschio di chiusura antincendio Ex 'd' che deve essere approvato per i requisiti di installazione.

Per applicazioni in presenza di polveri combustibili, il dispositivo di ingresso del cavo e gli elementi di protezione devono essere di tipo "e" con protezione superiore contro le esplosioni o di tipo "d" con chiusura antideflagrante e presentare una classificazione IP 6X conforme alla norma EN60529:1992.

**AVVERTENZE DI SICUREZZA:** qualora i lampeggiatori BExBG15D e BExBG10D siano utilizzati ad elevate temperature ambiente, ad es. oltre +40°C, la temperatura dei cavi di entrata può superare +70°C; si devono pertanto impiegare cavi adeguati resistenti al calore, dalla temperatura nominale di servizio di almeno 110°C.

## 12) Connessioni dei cavi

Vedere figura C e D / lo schema dei collegamenti elettrici E

## 13) Funzionamento sincronizzato

Tutti i lampeggiatori BExBG15D e BExBG10D collegati alla stessa linea di alimentazione lampeggeranno in modo sincronizzato, con un intervallo di un lampo per secondo. Per assicurarsi che i dispositivi siano sincronizzati controllare che la barretta di contatto del piedino non sia aderente, vale a dire che le due barrette di contatto non siano cortocircuitate insieme (vedi figura 4).

## 14) Funzionamento in accensione alternata

Due lampeggiatori possono essere installati vicini uno all'altro al fine di ottenere un funzionamento in circuito bistabile, in cui i due dispositivi lampeggiano alternativamente. Per realizzare questa modalità di funzionamento, installare una barretta di contatto del piedino sulla barretta di contatto dell'accensione alternata situata nelquadro elettronico, cioè le due barrette di contatto vengono cortocircuitate insieme (vedi figura 4), su uno dei due lampeggiatori. Il primo lampo del lampeggiatore sul quale è installata la barretta di contatto sarà ritardato di ½ secondo. I due dispositivi lampeggeranno quindi in modo alternato ogni ½ secondo.

## 15) Sistema di controllo di fine linea (unità CC)

Sulle unità CC BExBG15D e BExBG10D, se richiesto, è possibile utilizzare il sistema di controllo della linea di inversione CC. Tutte le lampeggiatori CC sono dotate di un diodo di bloccaggio nelle linee di ingresso dell'alimentazione. È possibile collegare ai morsetti positivo e negativo un diodo o un resistore di controllo di fine linea. Se viene utilizzato un resistore di fine linea, questo deve avere un valore di resistenza minimo di 33k ohm ed un wattaggio minimo di 0,5 W oppure un valore di resistenza minimo di 500 ohm ed un wattaggio minimo di 2 W.

## 2) Merking

Alle enheter har en etikett med følgende viktige informasjon:

Enhetsstypenr. BExBG15D eller BExBG10D

Inngangsspenning:

DC-enheter 48 V eller 24 V eller 12 V (10J only)  
AC-enheter 230 V eller 110 V eller 115 V

Kode: Ex d IIC T4 for Ta -50°C to +70°C  
Ex d IIC T5 for Ta -50°C to +40°C  
Ex tD A21 IP67 T125°C based on max. Ta of +70°C

Sertifikat nr. KEMA 00ATEX2006  
IECEx KEM 10.0002

Epsilon x:  
Utstyringsgruppe og -  
kategori:

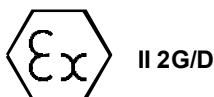

CE-merking:  
Varslet organ nr.

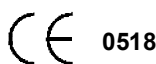

### “Advarsler”

MÅ IKKE ÅPNES I ATMOSFÆRE  
MED EKSPLOSIV GASS  
ELLER EKSPLOSIVT STØV

DEKKEBOLTER KLASSE A4-80

BRUK VARMEBESTANDIGE KABLER OG  
KABELMUFFER (godkjent for 110°C) VED  
OMGIVELSESTEMPERATURER OVER 40°C

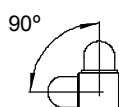

## 4) Installasjonskrav

Varsellys må installeres i samsvar med følgende eller tilsvarende standarder.

EN60079-14:2008	Elektriske installasjoner i farlige
IEC60079-14:2007 (Ed4)	områder (unntatt gruver)
EN60079-10:2003	Klassifisering av farlige områder
IEC60079-10:2008 (Ed1)	

Installering må kun utføres av kompetente personer, og alle gjeldende lokale bransjestandarder må overholdes.

## 5) Soner, gassgruppe, kategori og temperatur klassifisering

Enheterne kan installeres på steder med følgende forhold:

oneklassifisering, gass:

Sone 1	Ekspllosiv gass/luft-blanding som sannsynligvis forekommer ved normal drift.
Sone 2	Ekspllosiv gass/luft-blanding som ikke vanligvis vil forekomme, og om den gjør det, kun vil forekomme i kort tid.

Gassgrupperinger:

Gruppe IIA	Propan
Gruppe IIB	Etylen
Gruppe IIC	Hydrogen og acetylen

Temperaturklassifisering:

T1	400° C
T2	300° C
T3	200° C
T4	135° C

T5	100° C	Amb. +40° C
----	--------	-------------

Soneklassifisering, støv:

Sone 21	Ekspllosiv støv/luft-blanding vil sannsynligvis opptre ved normal bruk.
Sone 22	Ekspllosiv støv/luft-blanding vil sannsynligvis ikke opptre, og hvis det skjer, vil den kun foreligge i kort tid.

IP-klasse: IP67 T125°C Ta ≤ +70°C  
T110°C Ta ≤ +55°C  
T95°C Ta ≤ +40°C

Utstyringskategori: 2G/D

Omgivelsestemperaturområde:

-50°C to +70°C  
(T5 = +40°C)

## 6) Plassering og montering av varsellys

Se tegningen. A

**SIKKERHETSADVARSEL:** BExBG15D og BExBG10D 15 og 10 joule varsellys må monteres med kuppelen i en posisjon mellom rett stilling og 90°, som vist.

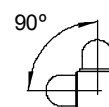

**SIKKERHETSADVARSEL:** Kuppelen må ikke på noe tidspunkt fjernes fra enheten.

## 7) Tilgang til flammesikkert hus

Se tegningen. B

Merk: De fire **M6-skrue**ne er av rustfritt stål klasse **A4-80**, og kun skruer i denne kategorien kan brukes til disse lydalarmerne. Derfor er det viktig at disse skruene med tilhørende fjærskiver oppbevares på et sikkert sted under installeringen.

## 8) Valg av strømforsyning

Systemets strømforsyning må ha tilstrekkelig kapasitet til å forsyne alle varsellysene som er koplet til systemet med strøm.

Tabellen nedenfor viser hvor mye inngangsstrøm de forskjellige varsellysene benytter:

Enhetsstype	Inngangsspenning	Inngangsstrøm	Maks I/P volt
BExBG15D	24V DC	860mA	30V
BExBG15D	48V DC	480mA	58V
BExBG15D	230V AC	170mA	253V
BExBG15D	115V AC	360mA	126V
BExBG10D	12V DC	1.45A	15V
BExBG10D	24V DC	660mA	30V
BExBG10D	48V DC	340mA	58V
BExBG10D	230V AC	110mA	253V
BExBG10D	115V AC	250mA	126V

Tabellen ovenfor viser også maksimale spenninger som varsellys kan benyttes ved.

## 9) Valg av kabler

Kablene må kunne håndtere strømmen som trekkes fra alle enhetene på linjen.

**SIKKERHETSADVARSEL:** Hvis BExBG15D og BExBG10D varsellys brukes ved høye omgivelsestemperaturer, dvs. over +40 °C, kan kabelinngangstemperaturen overstige +70 °C. Derfor må egnede varmebestandige kabler brukes, med nominell tjenestetemperatur på minst 110 °C.

## 10) Jording

Både AC- og DC-alarmentheter må koples til jordforbindelse av god kvalitet. Enhetene leveres med interne og eksterne jordingsterminaler, som begge sitter på terminalkammerdelen av enheten (se figur 2 og 3).

Ved bruk av eksterne jordterminaler må en benytte en kabelkrympesko. Kabelskoen skal settes mellom de to flate M5-fjærskivene av rustfritt stål. M5-fjærskiven må festes mellom den ytre flate skiven og M5-mutteren av rustfritt stål for å sikre at kabelskoen ikke kan løsnes eller vrís.

## 11) Kabelmuffer

Varsellys har doble kabelmuffeinnganger med M20 x 1,5 inngangsgjenger. Kun kabelmuffer godkjent for Ex 'd'-bruk kan brukes, og de må være egnet for typen kabel som brukes, samt overholde kravene i standarden for Ex 'd'

flammesikker installering, EN60079-14:2008 / IEC60079-14:2007.

Når kun én kabelinngang benyttes, må den andre lukkes med en Ex 'd' flammesikker lukkeplugg, som må være godkjent for de aktuelle installasjonskravene.

For bruk med brennbar støv skal kabelinnføringsenheten og tetningsdelene være av typen med økt eksplosjonssikkerhet "e" eller flammesikker kapsling "d", og den skal ha IP 6X-klasse ifølge EN60529:1992.

**SIKKERHETSADVARSEL:** Hvis BExBG15D og BExBG10D varsellys brukes ved høye omgivelsestemperaturer, dvs. over +40 °C, kan kabelinngangstemperaturen overstige +70 °C. Derfor må egnede varmebestandige kabler brukes, med nominell tjenestetemperatur på minst 110 °C.

## 12) 12) Kabelforbindelser

Se tegningen. C og D / kablingsskjemaet. E

## 13) Synkronisert drift

Alle BExBG15D og BExBG10D-varsellys som er koplet til samme ledning har synkronisert blinkhastighet med ett blink i sekundet. For å sikre at enhetene blir synkronisert, må du kontrollere at stiftsamleren\* ikke er montert, dvs. de to stiftene skal ikke være kortsluttet (se figur 4).

## 14) Flipflop

To varsellys kan monteres nær inntil hverandre for å gi flipflop-drift, der varsellysene blinker vekselvis. For å oppnå dette, monteres en stiftsamler på flipflop-stiftene på elektronikkortet, dvs. de to stiftene kortsluttes sammen (se figur 4) på ett av de to varsellysene. Det første blinket på varsellyset med samleren blir forsinket med ½ sekund. De to varsellysene blinker så vekselvis hver ½ sekund.

## 15) Slutt på linje-overvåking (DC-enheter)

På BExBG15D- og BExBG10D DC-enheter, kan likestrømsreversert linjeovervåking benyttes om nødvendig. Alle DC-alarmer har en blokkeringsdiode montert i inngangslinjene. En slutt på linje-overvåkingsdiode eller slutt på linje-overvåkingsresistor kan kobles over +ve- og -ve-terminalene. Hvis en slutt på linje-resistor benyttes, må den ha minste motstandsverdi 3k3 ohm, og minste wattverdi 0,5 watt, eller minste motstandsverdi 500 ohm og minste wattverdi 2 watt.

## 2) Marcação

Todas as unidades têm uma placa de especificações com a seguinte informação importante:

Nº de Tipo de Unidade BExBG15D ou BExBG10D

Tensão de entrada:  
Unidades CC 48V ou 24V ou 12V (10J only)  
Unidades CA 230V ou 115V

Code: Ex d IIC T4 for Ta -50°C to +70°C  
Ex d IIC T5 for Ta -50°C to +40°C  
Ex tD A21 IP67 T125°C based on max. Ta of +70°C

Código: KEMA 00ATEX2006  
IECEX KEM 10.0002

Épsilon x:  
Grupo e Categoria  
do Equipamento:

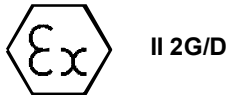

Marcação CE:  
Nº Entidade  
Notificada



**“Advertências** NÃO ABRIR QUANDO EXISTE  
UMA ATMOSFERA EXPLOSIVA  
DE GÁS OU POEIRAS

PARAFUSOS COBERTURA CLASSE A4-80

USE CABOS E TUBOS RESISTENTES AO CALOR  
(Capacidade 110°C) A TEMPERATURAS AMB. ACIMA 40°C

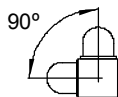

## 4) Requisitos de instalação

As faróis devem ser instaladas em conformidade com as seguintes normas ou outras equivalentes.

EN60079-14:2008 Instalações eléctricas em áreas perigosas (excepto minas)  
IEC60079-14:2007 (Ed4)  
EN60079-10:2003 Classificação de áreas perigosas  
IEC60079-10:2008 (Ed1)

A instalação deve ser efectuada apenas por pessoal competente e aplicam-se quaisquer códigos de prática vigentes no local.

## 5) Classificação de zonas, grupo de gases, categoria e temperatura

As unidades podem ser instaladas em locais com as seguintes condições:

### Classificação da Área Gás:

Zona 1	Probabilidade de ocorrência de mistura gasosa explosiva em funcionamento normal.
Zona 2	Improbabilidade de ocorrência de mistura gasosa explosiva; mesmo que tal ocorra, só será por período curto.

### Grupos de gases:

Grupo IIA	Propano
Grupo IIB	Etileno
Grupo IIC	Hidrogénio e acetileno

### Classificação da temperatura:

T1	400° C
T2	300° C
T3	200° C
T4	135° C

T5	100° C	Amb. +40°C
----	--------	------------

### Classificação da Área Poeiras:

Zona 21	Possibilidade de ocorrência de mistura explosiva de ar e poeiras durante o funcionamento normal.
Zona 22	A ocorrência de mistura explosiva de ar e poeiras não é provável, e se existir, será apenas por um curto período de tempo.

**Classificação IP:** IP67 T125°C Ta ≤ +70°C  
T110°C Ta ≤ +55°C  
T95°C Ta ≤ +40°C

**Categoria do equipamento:** 2G/D

### Variação da temperatura ambiente:

-50°C to +70°C  
(T5 = +40°C)

## 6) Localização e montagem do farol

Consulte o desenho A

**AVISO DE SEGURANÇA:** Os faróis BExBG15D e BExBG10D de 15 e 10 joules devem ser montados com a luz numa posição entre a vertical e 90°, conforme ilustrado.

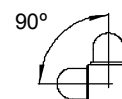

**AVISO DE SEGURANÇA:** A protecção da luz nunca deve ser retirada da unidade.

## 7 Acesso à caixa à prova de fogo

Consulte o desenho B

Note que os quatro parafusos M6 são de aço inoxidável da Classe A4-80; apenas podem ser utilizados parafusos desta categoria nestas sirenes. Por isso, é importante que estes parafusos e respectivas anilhas de mola sejam guardados num lugar seguro durante a instalação

## 8) Selecção da fonte de alimentação

A fonte de alimentação do sistema deve ter a capacidade necessária para fornecer a corrente de entrada a todos os faróis ligados ao sistema.

A tabela que se segue indica a corrente consumida pelos vários faróis:

Tipo de Unidade	Tensão de entrada	Corrente de entrada	Tensão máx.
BExBG15D	24V DC	860mA	30V
BExBG15D	48V DC	480mA	58V
BExBG15D	230V AC	170mA	253V
BExBG15D	115V AC	360mA	126V
BExBG10D	12V DC	1.45A	15V
BExBG10D	24V DC	660mA	30V
BExBG10D	48V DC	340mA	58V
BExBG10D	230V AC	110mA	253V
BExBG10D	115V AC	250mA	126V

A tabela acima mostra também as tensões máximas permitidas para funcionamento das faróis.

## 9) Selecção de cabos

Os cabos têm de suportar a corrente consumida por todas as unidades na linha.

**AVISO DE SEGURANÇA:** Se os faróis BExBG15D e BExBG10D forem utilizados em temperaturas ambiente elevadas, isto é, acima de +40° C, a temperatura de entrada do cabo pode exceder +70° C, pelo que, devem ser utilizados cabos resistentes ao calor, com uma capacidade nominal de temperatura de serviço nunca inferior a 110° C.

## 10) Ligação à terra

Tanto as unidades de faróis CA como CC devem ter uma boa ligação à terra. As unidades estão equipadas com terminais internos e externos de ligação à terra, ambos localizados na secção da câmara de terminais da unidade (veja as figuras 2 e 3).

Quando usar o terminal externo de ligação à terra deve usar um terminal do condutor cravado. O terminal do condutor deve estar localizado entre as duas anilhas chatas de aço inoxidável M5. A anilha de mola em aço inoxidável M5 deve estar presa entre a anilha chata externa e a porca em aço inoxidável M5 para garantir a fixação do terminal do condutor e que o mesmo não se solta nem torce.

## 11) Tubos

As faróis possuem tubos para entrada de dois cabos com fios de entrada M20 x1.5. Pode-se usar somente tubos aprovados para aplicações à prova de explosão, que devem

ser adequados ao tipo de cabo a ser usado e satisfazer também os requisitos da norma EN60079-14:2008 / IEC60079-14:2007 relativa à instalação à prova de fogo e de explosão.

Quando se usar somente uma entrada de cabo, a outra deve estar fechada com tampão de disco à prova de fogo e explosão, que deve ser aprovado para os requisitos de instalação.

Para aplicações de poeiras combustíveis, o dispositivo de entrada de cabo e os elementos de supressão devem ser do tipo "e" de maior protecção contra explosão ou ter isolamento à prova de chama "d" e devem ter uma classificação IP 6X de acordo com EN60529:1992.

**AVISO DE SEGURANÇA:** Se os faróis BExBG15D e BExBG10D forem utilizados em temperaturas ambiente elevadas, isto é, acima de +40° C, a temperatura de entrada do cabo pode exceder +70° C, pelo que, devem ser utilizados cabos resistentes ao calor, com uma capacidade nominal de temperatura de serviço nunca inferior a 110° C.

## 12) Ligações do cabo

Consulte o desenho C e D / o diagrama de ligações E

## 13) Operação sincronizada

Todos os faróis BExBG15D e BExBG10D que estão ligados à mesma linha de alimentação têm uma taxa de disparo sincronizada de um disparo por segundo. Para se certificar de que todas as unidades estão sincronizadas, verifique se o suporte do pino não está montado, isto é, se os dois suportes dos pinos não estão em curto-circuito (veja a Figura 4).

## 14) Operação "Flip-Flop"

Dois faróis podem ser montados próximo um do outro para funcionarem no modo "flip-flop", em que os faróis disparam alternadamente. Para conseguir este modo de operação, coloque um suporte do pino nos suportes alternados do quadro electrónico, ou seja os dois suportes dos pinos estão curto-circuito, (veja a figura 4) num dos dois faróis. O primeiro disparo no farol que tem o suporte instalado sofre um atraso de meio segundo. Os dois faróis disparam alternadamente de meio em meio segundo.

## 15) Monitorização de fim de linha (Unidades CC)

Nas unidades CC BExBG15D e BExBG10D DC, pode-se utilizar monitorização de linha inversa cc, se necessário. Todas as faróis CC possuem um diodo de bloqueio nas suas linhas de entrada de alimentação. Um diodo de monitorização de fim de linha ou uma resistência de monitorização de fim de linha podem ser ligada aos terminais +ve e -ve. Se for utilizada uma resistência de fim de linha, esta deve ter um valor de resistência mínimo de 3k3 ohms e uma potência mínima de 0,5 watts ou um valor de resistência mínimo de 500 ohms e uma potência mínima de 2 watts.

## 2) Marcas

Todas las unidades llevan una etiqueta de clasificación con la siguiente información importante: -

Nº de tipo de unidad.      BExBG15D o BExBG10D

Voltaje de entrada:  
 Unidades de CC 48 V o 24 V o 12V (10J Only)  
 Unidades de CA 230 V o 115V

Código:            Ex d IIC T4 for Ta -50°C to +70°C  
                       Ex d IIC T5 for Ta -50°C to +40°C  
                       Ex tD A21 IP67 T125°C based on max. Ta of +70°C

Certificate No.    KEMA 00ATEX2006  
                           IECEx KEM 10.0002

Epsilon x:  
 Categoría y grupo  
 de equipamiento:

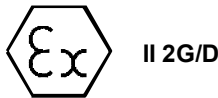

Marca CE:  
 Nº de cuerpo de



**“Avisos”**    NO ABRIR EN AMBIENTES CON POLVO  
 O PRESENCIA DE UN GAS EXPLOSIVO

PERNOS DE LA CUBIERTA CLASE A4-80

UTILICE CABLES Y CASQUILLOS DE CABLE RESISTENTES AL CALOR (Clasificados a 110°C) A TEMPERATURAS AMBIENTE SUPERIORES A 40°C

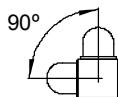

## 4) Requisitos de instalación

Las sondas acústicas deben instalarse conforme a las siguientes normas o sus equivalentes.

EN60079-14:2008      Instalaciones eléctricas en áreas peligrosas (exceptuando minas)  
 IEC60079-14:2007 (Ed4)      Clasificación de áreas peligrosas  
 EN60079-10:2003  
 IEC60079-10:2008 (Ed1)

La instalación únicamente debe llevarse a cabo por parte de personal competente y debe observarse cualquier código de práctica local.

## 5) Clasificación de zonas, grupo de gas, categoría y temperatura

Las unidades pueden instalarse en ubicaciones que cumplan las siguientes condiciones: -

**Gas de clasificación por área:**

Zona 1	Mezcla explosiva de aire y gas que es posible ocurra durante el funcionamiento normal.
Zona 2	Mezcla explosiva improbable de aire y gas que, de producirse, lo hará sólo por breve tiempo.

**Grupos de gas:**

Grupo IIA	Propano
Grupo IIB	Etileno
Grupo IIC	Hidrógeno y acetileno

**Clasificación de temperatura:**

T1	400° C
T2	300° C
T3	200° C
T4	135° C

T5	100° C	Amb. +40°C
----	--------	------------

Polvo de clasificación por área:

Zona 21	Es posible la existencia de una mezcla de aire y polvo explosivo durante el funcionamiento.
Zona 22	La existencia de una mezcla de aire y polvo explosivo no es muy probable y si se da sólo durará un breve espacio de tiempo.

**Clasificación IP:**            IP67    T125°C    Ta ≤ +70°C  
     T110°C    Ta ≤ +55°C  
     T95°C     Ta ≤ +40°C

**Categoría de equipamiento:**      2G/D

**Rango de temperatura ambiente:**

-50°C to +70°C  
 (T5 = +40°C)

## 6) Ubicación y montaje del radiofaro

Véase el diagrama A

**AVISO SOBRE SEGURIDAD:** Los radiofaros BExBG15D y BExBG10D de 15 y 10 julios deben montarse con la cúpula destellante en una posición entre vertical y de 90°, como se muestra.

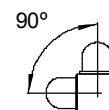

**AVISO SOBRE SEGURIDAD:** La protección de la cúpula destallante no debe retirarse de la unidad en ningún momento.

## 7) Access Acceso a la caja antideflagrante

Véase el diagrama B

Obsérvese que los cuatro tornillos M6 son de acero inoxidable de clase A4-80 y que con estas sondas acústicas únicamente deben utilizarse tornillos de esta categoría. Por ello, es importante que estos tornillos, y las arandelas elásticas se guarden en un lugar seguro durante la instalación.

## 8) Selección de la fuente de alimentación

La fuente de alimentación del sistema debe tener la capacidad necesaria para proporcionar la corriente de entrada a todos los radiofaros conectados al sistema.

La tabla que aparece a continuación muestra la corriente de entrada que usan los diferentes radiofaros: -

Tipo de unidad	Voltaje entrada	Corriente entrada	IP máx volts
BExBG15D	24V DC	860mA	30V
BExBG15D	48V DC	480mA	58V
BExBG15D	230V AC	170mA	253V
BExBG15D	115V AC	360mA	126V
BExBG10D	12V DC	1.45A	15V
BExBG10D	24V DC	660mA	30V
BExBG10D	48V DC	340mA	58V
BExBG10D	230V AC	110mA	253V
BExBG10D	115V AC	250mA	126V

Esta tabla también muestra los voltajes máximos con los que pueden funcionar las sondas acústicas.

## 9) Selección de cables

Los cables deben tener la capacidad necesaria para manipular la corriente extraída de todas las unidades en la línea.

**AVISO SOBRE SEGURIDAD:** Si los radiofaros BExBG15D y BExBG10D se utilizan a temperaturas ambiente altas, es decir, superiores a +40° C, la temperatura de entrada del cable puede superar los +70° C y, por lo tanto, deben usarse cables resistentes al calor adecuados, con una temperatura de servicio nominal de al menos 110° C.

## 10) Puesta a tierra

Tanto las sondas acústicas de CA como de CC deben tener una buena conexión a tierra. Las unidades tienen bornes de tierra internos y externos, ubicadas en la sección de la cámara de bornes de la unidad (véanse las ilustraciones 2 y 3).

Cuando se utilicen los bornes de tierra externos, debe utilizarse un talón de cable fruncido. El talón de cable se situará entre las dos arandelas planas M5 de acero inoxidable. La arandela elástica M5 de acero inoxidable debe colocarse entre la arandela plana exterior y la tuerca M5 de acero inoxidable a fin de asegurar que el talón del cable no se afloje ni retuerza.

## 11) Casquillos de los cables

Las sondas acústicas tienen casquillos de cable de entrada doble con roscas de entrada de M20 x 1,5. Únicamente deben utilizarse casquillos de cable aprobados para aplicaciones Ex 'd', los cuales deben ser adecuados para el tipo de cable que se está utilizando, además de satisfacer los requisitos de la norma EN60079-14:2008 / IEC60079-14:2007 para instalaciones antideflagrantes Ex 'd'.

Cuando solamente se utilice una entrada de cable, la otra deberá cerrarse con un tapón de obturación antideflagrante Ex 'd' debidamente aprobado para los requisitos de la instalación.

Para las aplicaciones de polvo combustible, el dispositivo de entrada del cable y los elementos de supresión deberán estar en la protección de tipo de explosión de seguridad aumentada "e" o en el recinto a prueba de explosión "d" y tendrán que tener una clasificación IP 6X de acuerdo con EN60529:1992.

**AVISO SOBRE SEGURIDAD:** Si los radiofaros BExBG15D y BExBG10D se utilizan a temperaturas ambiente altas, es decir, superiores a +40° C, la temperatura de entrada del cable puede superar los +70° C y, por lo tanto, deben usarse cables resistentes al calor adecuados, con una temperatura de servicio nominal de al menos 110° C.

## 12) Conexiones de los cables

Véase el diagrama C y D / diagrama de cableado E

## 13) Funcionamiento sincronizado

Todos los radiofaros BExBG15D y BExBG10D conectados a la misma línea de suministro tienen una frecuencia de destello sincronizada de un destello por segundo. A fin de asegurar que las unidades estarán sincronizadas, compruebe que no esté instalado el cabezal de patillas, es decir, que dos patillas del cabezal no estén cortocircuitadas (véase la Ilustración 4).

## 14) Funcionamiento biestable

Pueden montarse dos radiofaros próximos entre sí a fin de obtener un funcionamiento biestable, por el cual los radiofaros destellarán alternativamente. A fin de lograr este modo de funcionamiento, ajuste un cabezal de patilla a las patillas del cabezal biestable del tablero electrónico, es decir, las dos patillas del cabezal están cortocircuitadas (véase la ilustración 4) en uno de los

## 15) Vigilancia de fin de línea (Unidades de CC)

En las unidades BExBG15D y BExBG10D de CC, puede utilizarse la vigilancia de línea inversa si fuera necesario. Todas las sondas acústicas de CC llevan un diodo de bloqueo en las líneas de entrada de suministro. Puede ajustarse un diodo de vigilancia de fin de línea o una resistencia de vigilancia de fin de línea a lo largo de los bornes +ve y -ve. Si se utiliza una resistencia de fin de línea, ésta deberá tener un valor mínimo de resistencia de 3k3 ohmios y un vataje mínimo de 0,5 vatios o un valor mínimo de resistencia de 500 ohmios y un vataje mín. de 2 vatios.



## 2) Märkning

Samtliga enheter är försedda med märkplåt med följande viktiga information:

Typ: BExBG15D eller BExBG10D

Matningsspänning:  
 DC-enheter 48V, 24V eller 12V (10J only)  
 AC-enheter 230V eller 115V

Kod:  
 Ex d IIC T4 for Ta -50°C to +70°C  
 Ex d IIC T5 for Ta -50°C to +40°C  
 Ex tD A21 IP67 T125°C based on max. Ta of +70°C

Certifiering: KEMA 00ATEX2006  
 IECEx KEM 10.0002

Epsilon x:  
 Utrustningsgrupp  
 och kategori:

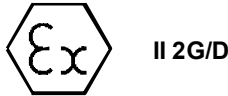

CE-märkning:  
 Ansvarigt organ:

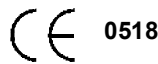

**WARNING!** ÖPPNAS EJ I NÄRVARO AV EXPLOSIVA  
 GAS- ELLER DAMMATMOSFÄRER

KAPSLINGSBULTAR KLASS A4-80

ANVÄND VÄRMEBESTÄNDIGA KABLAR OCH  
 KABELGENOMFÖRINGAR (med märktemp 110°C) VID  
 OMGIVNINGSTEMPERATURER ÖVER 40°C

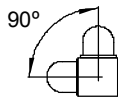

## 4) Installationskrav

Högtalarna skall installeras enligt följande eller likvärdiga standarder.

EN60079-14:2008	Elektriska installationer inom riskområden (utom gruvor)
IEC60079-14:2007 (Ed4)	
EN60079-10:2003	Klassning av explosionsfarliga områden
IEC60079-10:2008 (Ed1)	

Installation skall endast göras av behörig personal under tillämpande av lokala bestämmelser.

## 5) Zoner, explosionsgrupper, kategori och T-klasser

Enheterna får installeras på platser där följande förhållanden råder:-

### Zonindelning för gas:

<b>Zon 1</b>	Explosiv gasblandning förväntas förekomma vid normal drift.
<b>Zon 2</b>	Explosiv gasblandning förväntas förekomma sällan och då endast kortvarigt.

### Explosionsgrupper:

Grupp IIA	Propan
Grupp IIB	Etylen
Grupp IIC	Väte och acetylen

### T-klasser:

T1	400° C
T2	300° C
T3	200° C
T4	135° C

T5	100° C	Amb. +40°C
----	--------	------------

### Zonindelning för damm:

<b>Zon 21</b>	Explosiv dammatmosfär i form av moln kan väntas förekomma under normal drift.
<b>Zon 22</b>	Explosiv dammatmosfär i form av moln väntas inte förekomma och, om den likväl förekommer, i så fall sannolikt endast kortvarigt.

**IP-klassning:** IP67 T125°C Ta ≤ +70°C  
 T110°C Ta ≤ +55°C  
 T95°C Ta ≤ +40°C

**Utrustningskategorier:** 2G/D

### Omgivningstemperatur:

-50°C to +70°C  
 (T5 = +40°C)

## 6) Placering och montering av varningslampa

Se ritning A

**SÄKERHETSVARNING:** Varningslamporna BExBG15D och BExBG10D på 15 respektive 10 joule måste monteras med kupolen mellan upprätt läge och 90°, se bild.

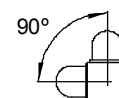

**SÄKERHETSVARNING:** Kupolen måste alltid vara monterad på enheten.

## 7) Åtkomst till den explosionstäta kapslingen

Se ritning B

Observera att de fyra **M6-skruvarna är av klass A4-80 och av rostfritt stål. Endast dessa skruvar skall användas till högtalarna.** Därför är det viktigt att dessa skruvar och dess fjäderbrickor läggs på ett säkert ställe under installationen.

## 8) Val av kraftförsörjning

Kraftförsörjningen till systemet måste ha tillräcklig kapacitet för att kunna förse samtliga varningslampor på systemet med ström.

I följande tabell anges hur mycket ström de olika varningslamporna förbrukar:

Typ	Ingångsspänning	Ingångsström	Max. spänning
BExBG15D	24V DC	860mA	30V
BExBG15D	48V DC	480mA	58V
BExBG15D	230V AC	170mA	253V
BExBG15D	115V AC	360mA	126V
BExBG10D	12V DC	1.45A	15V
BExBG10D	24V DC	660mA	30V
BExBG10D	48V DC	340mA	58V
BExBG10D	230V AC	110mA	253V
BExBG10D	115V AC	250mA	126V

Tabellen ovan visar också högtalarnas högsta driftspänning.

## 9) Val av kabel

Kablarna måste vara dimensionerade för att klara strömbelastningen från alla anslutna enheter.

**SÄKERHETSVARNING:** Om varningslamporna BExBG15D och BExBG10D används vid hög omgivningstemperatur, dvs över +40°C, kan temperaturen vid kabelingången överstiga +70°C. Värmebeständiga kablar med en märkdrifttemperatur på minst 110°C måste därför användas.

## 10) Jordning

Både AC- och DC-högtalarna måste jordas på tillfredsställande sätt. Enheterna har interna och externa jordanslutningar, vilka båda är placerade i enhetens kopplingshus (se bild 2 och 3).

När den externa jordanslutningen används skall en kontaktpressad kabelsko monteras. Kabelskon skall placeras mellan de två flata rostfria stålbrickorna (M5). Fjäderbrickorna av rostfritt stål (M5) skall monteras mellan den yttre flata brickan och den rostfria stålmuttern (M5) för att säkerställa att kabelskon inte lossnar eller vrids.

## 11) Kabelgenomföringar

Högtalarna har dubbla kabelingångar med M20 x 1,5 gänga. Endast kabelgenomföringar godkända för Ex 'd'-bruk får användas. Dessa måste passa den typ av kabel som används och dessutom uppfylla kraven för explosionstät kapsling (Ex 'd') enligt EN60079-14:2008 / IEC60079-14:2007.

Om endast en kabelingång används skall den andra tillslutas med en Ex 'd' explosionssäker avslutningsnippel

För lättantändliga dammanvändningsområden, skall kabelgenomföringsprodukten och blindpluggar vara av typen explosionsskydd med förhöjd säkerhet "e" eller explosionstät kapsling "d", och skall vara IP 6X-klassad enligt EN60529:1992.

**SÄKERHETSVARNING:** Om varningslamporna BExBG15D och BExBG10D används vid hög omgivningstemperatur, dvs över +40°C, kan temperaturen vid kabelingången överstiga +70°C. Värmebeständiga kablar med en märkdrifttemperatur på minst 110°C måste därför användas.

## 12) Kabelanslutningar

Se ritning C och D / kopplingschema. E

## 13) Synkroniserad drift

Samtliga varningslampor BExBG15D och BExBG10D som är anslutna till samma ledning har synkroniserad blinkningsfrekvens med en blinkning per sekund. För att enheterna ska vara synkroniserade ska bygeln mellan stiften inte vara monterad, dvs de båda stiftarna ska inte vara kortslutna (se fig.4).

## 14) Alternerande drift

Två varningslampor som är monterade intill varandra kan även fungera i en alternerande blinkningssekvens. För att uppnå det bygglas de båda flipflopstiften på en av lampornas elektronikkort så att de båda stiftarna på den lampan kortsluts (se fig. 4). Den första blinkningen på varningslampan med byglade stift fördröjs då med en halv sekund. De båda varningslamporna blinkar då i alternerande följd två gånger i sekunden.

## 15) Ledningsövervakning (DC-enheter)

Ledningsövervakning kan vid behov användas på DC-enheter BExBG15D och BBxBG10D. Alla DC-högtalare har en blockeringsdiod installerad i ingångsledningen. En bevakningsdiod eller ett bevakningsmotstånd kan anslutas över plus- och minuspolerna. Om ett bevakningsmotstånd används skall resistansen vara minst 3,3 kohm och effekten minst 0,5 watt eller minst 500 ohm och minst 2 watt.